



Operation **Manual**

Goodrive20-09 Series **VFD for Hoisting**



SHENZHEN INVT ELECTRIC CO., LTD.

Preface

Thank you for choosing Goodrive20-19 series open-loop vector variable-frequency drives (VFDs) for hoisting machinery.

Goodrive20-09 are VFDs special for hoisting developed by INVT based on load characteristics and control requirements of electric hoists, European cranes, small tonnage gantry or bridge cranes, which integrates hoisting-oriented brake logic and conical motor control logic. The VFD has hoisting-oriented functions, such as torque verification, brake feedback, zero position detection, range limit, overload protection, light-load speed boost, motor overtemperature protection and so on.

Goodrive20-09 series VFDs are configured with compact structure and size. All series VFDs have built-in brake units, saving installation space. The VFDs in some power ranges carry built-in DC reactors, improving efficiency. The VFDs can satisfy the low noise and low electromagnetic interference requirements for the overall EMC design. In addition, the VFDs can withstand challenging grid, temperature, humidity, and dust conditions, greatly enhancing product reliability.

This operation manual instructs you how to install, wire, set parameters for, diagnose and remove faults for, and maintain Goodrive20-09 series VFDs, and also lists related precautions. Before installing a Goodrive20-09 VFD, read through this manual carefully to ensure the proper installation and running with the excellent performance and powerful functions into full play.

If the product is ultimately used for military affairs or manufacture of weapons, please comply with the relevant provisions of the Foreign Trade Law of the People's Republic of China on export control, and go through the corresponding export formalities.

We reserve the right to update the manual information without prior notice.

Contents

Preface	i
Contents	ii
1 Safety precautions	1
1.1 Safety definition	1
1.2 Warning signs	1
1.3 Safety guide	2
2 Product overview	4
2.1 Precautions for quick application	4
2.2 Product specifications	6
2.3 Product nameplate	10
2.4 Model code	10
2.5 Rated specifications	10
2.6 Structure diagram	11
3 Installation guide	15
3.1 Mechanical installation	15
3.2 Standard wiring	18
3.3 Wiring protection	26
4 Commissioning guide	28
4.1 Commissioning lifting in open-loop vector control	28
4.2 Commissioning lifting in space voltage vector control	31
4.3 Commissioning horizontal moving	34
4.4 Commissioning the conical motor function	37
4.5 Commissioning the brake function.....	39
4.6 Commissioning analog reference operating lever	45
4.7 Commissioning graded reference operating lever	47
4.8 Commissioning multi-step speed reference.....	49
4.9 Commissioning motor-actuated potentiometer	51
5 Keypad operation	54
5.1 Keypad introduction	54
5.2 Keypad display.....	56
5.3 Operations on keypad.....	57
6 Function parameter list	60
7 Fault tracking	114
7.1 Fault prevention	114
7.2 Fault handling	119
8 485 communication protocol	127
Appendix A Technical data	132
A.1 Derated application.....	132

A.2 EMC regulations	133
Appendix B Dimension drawings	135
B.1 External keypad structure	135
B.2 VFD dimensions	136
Appendix C Optional peripheral accessories	141
C.1 Wiring of peripheral accessories	141
C.2 Power supply	143
C.3 Cables	143
C.4 Breaker and electromagnetic contactor	144
C.5 Reactors	145
C.6 Filters	146
C.7 Braking resistors	149
C.8 Leakage current and RCD	151
C.9 Recommended PTC model selection	153
Appendix D Further information	154
D.1 Product and service queries	154
D.2 Feedback on INVT VFD manuals	154
D.3 Documents on the Internet	154

1 Safety precautions

Read this manual carefully and follow all safety precautions before moving, installing, operating, and servicing the product. Otherwise, physical injury or death or damage to the devices may be caused.









For any physical injury or damage to the devices caused by you or your customers due to your neglect of the safety precautions, our company shall not be held liable.

1.1 Safety definition





- Danger:** Serious physical injury or even death may be caused if related requirements are not followed.
- Warning:** Physical injury or damage to the devices may be caused if related requirements are not followed.
- Note:** Steps to take for ensuring the proper running of the product.
- Trained and qualified electricians:** People working on the device must have taken part in professional electrical and safety training, obtained the certification, and been familiar with all steps and requirements for installing, performing commissioning on, operating, and maintaining the device, and are capable of preventing or dealing with all kinds of emergencies.

1.2 Warning signs

Warning signs are used to warn you about the conditions that may cause severe injury or damage to the device. They instruct you to exercise caution to prevent danger. The following table describes the warning signs used in this manual.

Sign	Name	Description	Abbreviation
 Danger	Danger	Serious physical injury or even death may be caused if related requirements are not followed.	
 Warning	Warning	Physical injury or damage to the devices may be caused if related requirements are not followed.	
 Electrostatic discharge	Electrostatic discharge	Damage to the PCBA board may be caused if related requirements are not followed.	
 Hot sides	Hot sides	The base of the device may become hot. Do not touch it.	
Note	Note	Steps to take for ensuring the proper running of the device.	Note

1.3 Safety guide

	<ul style="list-style-type: none"> ✧ Only trained and qualified electricians are allowed to operate the device. ✧ Do not perform any wiring, inspection, or component replacement operations when power is applied. Before wiring or inspection, ensure that all input power supplies are disconnected and wait for at least the waiting time specified on the variable-frequency drive (VFD), or ensure that the DC bus voltage is lower than 36 V. The following table describes the waiting time. <table border="1" data-bbox="239 361 925 426"> <thead> <tr> <th colspan="2" data-bbox="239 361 607 394">VFD model</th> <th data-bbox="607 361 925 394">Min. waiting time</th> </tr> </thead> <tbody> <tr> <td data-bbox="239 394 418 426">3PH 380 V</td> <td data-bbox="418 394 607 426">0.75kW–37kW</td> <td data-bbox="607 394 925 426">5 min</td> </tr> </tbody> </table>	VFD model		Min. waiting time	3PH 380 V	0.75kW–37kW	5 min
VFD model		Min. waiting time					
3PH 380 V	0.75kW–37kW	5 min					
	<ul style="list-style-type: none"> ✧ Do not refit the product unauthorizedly; otherwise fire, electric shocks or other injury may be caused. 						
	<ul style="list-style-type: none"> ✧ The base may become hot when the machine is running. Do not touch it. Otherwise, you may get burnt. 						
	<ul style="list-style-type: none"> ✧ The electronic parts and components inside the VFD are electrostatic sensitive parts. Take measurements to prevent electrostatic discharge when performing operations involving them. 						

1.3.1 Transport and installation

	<ul style="list-style-type: none"> ✧ Do not install the VFD on inflammables. Prevent it from coming into contact with or adhering to inflammables. ✧ Connect the optional brake components according to the wiring diagram. ✧ Do not operate the VFD if it is damaged or lack of components. ✧ Do not touch the VFD with wet objects or any of your body parts. Otherwise, electric shocks may be caused.
--	---

- ✧ Use proper handling and installation tools to avoid damage to the device or physical injury. Installers must take mechanical protective measures, such as wearing anti-smashing shoes and work clothes, to protect personal safety.
- ✧ Do not carry the machine only by its front cover. Otherwise, the machine may fall down.
- ✧ Ensure that no physical impact or vibration occurs on the VFD during its transport and installation.
- ✧ Install the VFD in a place that prevents children or other people from touching it.
- ✧ The leakage current of the VFD may be larger than 3.5 mA during operation. Perform reliable grounding and ensure that the grounding resistance is lower than 10 Ω. The conductivity of the PE grounding conductor is the same as that of the phase conductor (with the same sectional area).
- ✧ R, S, and T are the power input terminals, while U, V, and W are the the terminals for output to the motor. Connect the input power cables and motor cables properly. Otherwise, damage to the VFD may be caused.

1.3.2 Commissioning and operation

	<ul style="list-style-type: none"> ✧ Before wiring the terminals of the VFD, disconnect all power supplies applied to it and wait for at least the waiting time specified on it. ✧ The voltage is high inside the VFD when it is running. Except settings through the keypad, do not perform any other operations on it. ✧ The VFD may automatically start when the function of start upon power outage is enabled (P01.21=1). Do not approach the machine or motor. ✧ The VFD cannot be used as "Emergency-stop device". ✧ The VFD cannot act as an emergency brake for the motor. It is a must to install mechanical brake device.
--	---



- ✧ Do not switch on and off the input power supply of the VFD frequently.
- ✧ If the VFD has been stored for a long time, check, set the capacity of, and perform a test run on it before using it.
- ✧ Close the front cover of the VFD before running it. Otherwise, electric shocks may be caused.

1.3.3 Component maintenance and replacement

	<ul style="list-style-type: none"> ✧ Only trained and qualified electricians are allowed to maintain, check, and replace components of the VFD. ✧ Before wiring the terminals of the VFD, disconnect all power supplies applied to it and wait for at least the waiting time specified on it. ✧ During the maintenance and replacement of components, take measures to prevent screws, cables, and other conductive items from dropping into the VFD, and prevent electrostatic discharge for the VFD and its internal components.
--	---

- ✧ Tighten the screws with proper torque.
- ✧ During the maintenance and replacement of components, prevent the VFD and its parts and components from coming into contact with or being attached with inflammables.
- ✧ Do not perform any insulation or withstand voltage tests on the VFD. Do not use a megameter to measure the control circuit of the VFD.

1.3.4 Scrap disposition

	<ul style="list-style-type: none"> ✧ There is heavy metal in the parts and components of the VFD. Deal with it as industrial waste after it is scrapped.
	<ul style="list-style-type: none"> ✧ When the life cycle ends, the product should enter the recycling system. Dispose of it separately at an appropriate collection point instead of placing it in the normal waste stream.

2 Product overview

2.1 Precautions for quick application

2.1.1 Inspection during unpacking

Check the following items after receiving the product.

1. Whether the packing box is damaged or dampened. If problems described in the item are found, contact the local dealer or INVT office.

2. Whether the model identifier on the exterior surface of the packing box is consistent with the purchased model. If problems described in the item are found, contact the local dealer or INVT office.

3. Whether the interior surface of the packing box is abnormal, for example, in wet condition, or whether the enclosure of the product is damaged or cracked. If problems described in the item are found, contact the local dealer or INVT office.

4. Whether the nameplate of the product is consistent with the model identifier on the exterior surface of the packing box. If problems described in the item are found, contact the local dealer or INVT office.

5. Whether the accessories (including the user manual and keypad) inside the packing box are complete. If problems described in the item are found, contact the local dealer or INVT office.

2.1.2 Application confirmation

Confirm the following items before using the VFD.

Do not perform any insulation or voltage withstanding tests on the VFD. Do not use a megameter to measure the control circuit of the VFD.

1. Mechanical type of the load to be driven by the VFD. Check whether the VFD will be overloaded in actual operation.

2. Whether the actual running current of the to-be-loaded motor is lower than the rated current of the VFD.

3. Whether control precision implemented by the VFD meets the requirement of the actual load.

4. Whether the grid voltage is consistent with the rated voltage of the VFD.

2.1.3 Environment confirmation

Check the following items before you install and use the VFD.

1. Whether the ambient temperature in the application is higher than 40°C. If yes, derate the machine by 1% for every increased 1°C. Do not use the VFD in environments where the temperature is higher than 50°C.

Note: If the VFD is installed in a cabinet, the ambient temperature is the air temperature

inside the cabinet.
2. Whether the ambient temperature in the application is lower than -10°C . If yes, configure a heating device. Note: If the VFD is installed in a cabinet, the ambient temperature is the air temperature inside the cabinet.
3. When the altitude exceeds 1000m, derate by 1% for every increase of 100m. When the altitude exceeds 3000m, consult the local INVT dealer or office for details.
4. Whether the ambient humidity is higher than 90% or condensation occurs. If yes, take extra protective measures.
5. Whether there is direct sunlight or biological invasion in the application environment. If yes, take extra protective measures.
6. Whether there is dust or inflammable and explosive gas in the application environment. If yes, take extra protective measures.

2.1.4 Installation confirmation

Check the following items after the installation of the VFD is complete.

1. Whether the input power cables and motor cables meet the current-carrying capacity requirements of the actual load.
2. Whether the peripheral accessories are correctly selected and properly installed, and whether the installation cables meet the current-carrying capacity requirements of the accessories, including the input reactor, input filter, output reactor, output filter, and braking resistor.
3. Whether the VFD is installed on non-flammable materials, and whether its heat-emitting accessories (such as reactor and braking resistor) are kept away from inflammable materials.
4. Whether all the control cables are wired separately from power cables, and whether electromagnetic compatibility (EMC) specification requirements are taken into full account during the wiring.
5. Whether all the grounding systems are properly grounded according to the requirements of the VFD.
6. Whether all the installation spaces of the VFD meet the requirements stated in the manual.
7. Whether the installation of the VFD meets the requirements stated in the manual. Vertical installation should be adopted whenever possible.
8. Whether the external wiring terminals are tightened, and whether the torque meets the requirements.
9. Whether screws, cables, or other conductive items drop into the VFD. If yes, take them out.

2.1.5 Basic commissioning

Complete the basic commissioning as follows before using the VFD.

1. Perform autotuning if required. Remove the motor load, if possible, to perform dynamic parameter autotuning; and if the load cannot be removed, you can perform static autotuning.
2. Adjust the ACC/DEC time according to the actual operation conditions of the load.
3. Perform commissioning on the machine in jogging mode and check whether the rotating direction of the motor meets the requirement. If no, exchange the wires of any two phases of the motor to change the running direction of the motor.
4. Set all control parameters and then run the machine.

2.2 Product specifications

Function		Specification
Power input	Input voltage (V)	AC 3PH 380 V (-15%)–440 V (+10%) Rated voltage: 380 V
	Input current (A)	See section 2.5 "Rated specifications".
	Input frequency (Hz)	50 Hz or 60 Hz; Allowable range: 47–63 Hz
Power output	Output voltage (V)	0–input voltage
	Output current (A)	See section 2.5 "Rated specifications".
	Output power (kW)	See section 2.5 "Rated specifications".
	Output frequency (Hz)	0–150 Hz
Technical control performance	Control mode	SVPWM control and SVC
	Motor type	Asynchronous motors
	Speed regulation ratio	AM 1: 200 (SVC)
	Speed control precision	±0.2% (SVC)
	Speed fluctuation	±0.3% (SVC)
	Torque responsiveness	<20ms (SVC)
	Torque control accuracy	10% (SVC)
	Start torque	Asynchronous motors: 0.25 Hz/150% (SVC)
Overload capacity	Meet the load requirements of the duty type S3 (Intermittent periodic duty).	

Function		Specification
	Braking capacity	100% for long time, 120% for 1 minute, and 170% for 10 seconds
Operation control performance	Frequency setting mode	Digital, analog, multi-step speed running, graded multi-step speed, Modbus communication, etc. The setting modes can be used in combination and can also be switched between each other.
	Automatic voltage regulation	When the grid voltage changes, the output voltage can be kept constant.
	Fault protection	Protection against more than 30 faults is provided, where the faults include overcurrent, overvoltage, undervoltage, overtemperature, phase loss, underload, and overload.
Special function	Brake control	Embedded with hoisting-oriented brake logic, and integrated with the torque verification, brake feedback, zero position detection, restart after braking functions, which meet the industrial standards on the VFDs for hoisting.
	Conical motor control	Integrated with conical motor control algorithm. During startup, the magnetic flow is increased to release the brake. During stop, the magnetic flow is decreased to close the brake.
	Light-load speed boost	If the output current is less than the light-load speed-boost current detection value, the VFD will speed up to the set frequency.
	Range limit	The function is used to limit the hoist to run within the specified range. The VFD enables emergency stop and reports an alarm once the range is exceeded. Upward position limit: When it acts, upward running is limited. Downward position limit: When it acts, downward running is limited. Upward or downward DEC position: When the deceleration signal is valid, the running speed of the hoist is limited once the hoist runs within the slow speed area. Uni-directional speed limit. For example, only the upward running speed is limited when the hoist runs within the upward slow speed area.
	Hoisting application	Including lifting, horizontal moving, and conical motor application macros.

Function		Specification
	macro	
	Frequency derating with voltage	When the bus voltage is continuously low, the reference frequency is decreased to keep the normal output torque of VFD.
	Low voltage protection	When the bus voltage decrease transiently or the VFD quickly stops upon power outage, the low voltage protection can ensure the hook does not slip. The low voltage protection function is automatically disabled once the bus voltage is restored to the normal state.
	Low-speed running protection	The function is enabled to prevent the motor from being damaged due to long-time low-speed running. The VFD reports the low-speed running protection fault when the running frequency of the VFD is less than or equal to the set protection frequency and times out.
	Brake feedback	When the brake control signal is inconsistent with the brake feedback signal, the VFD reports the brake feedback fault (FAE) when the brake feedback delay is reached.
	Zero position detection	The zero position signal and running signal are mutually exclusive.
	Torque verification	If the output current or output torque of the VFD is greater than the set value and lasts for a fixed time before releasing the brake, the torque verification succeeds; if the torque verification fails after the detection time is reached, the VFD reports the verification fault.
	Jogging	After receiving a jogging command, the VFD can automatically start, run, and stop at the preset running frequency and time according to the settings. During the process, the brake can be normally opened or closed under the control of VFD, ensuring the stability without hook slip or exception when the crane starts or stops.
	Braking protection	30–37kW VFDs provide the braking unit short connection protection function.
Peripheral interface	Terminal analog input resolution	Not more than 20mV
	Terminal digital input resolution	Not more than 20mV
	Analog input	1 input, AI2: 0–10 V/0–20mA 5.5kW and higher VFD models are compatible with PT100 resistance input, and AI and PT100 is set by the jumper.

Function		Specification
	Digital input	Eight common inputs, of which two inputs supports PTC input, and the PTC acting at 2.5k Ω . Internal impedance: 6.6k Ω Maximum input frequency: 1kHz, Supporting internal power supply 24V, Supporting external power supply (-20%) 24–48 V DC (+10%), and (-10%) 24–48 V AC (+10%) voltage inputs. Bi-directional input terminals, supporting both NPN and PNP modes
	Relay output	3 programmable relay outputs; RO1A is in the normally open (NO) state, RO1B is in the normally closed (NC) state, and RO1C is the common terminal; RO2A is in the NO state, and RO2C is the common terminal; RO3A is in the NO state, and RO3C is the common terminal.
Others	Operation ambient temperature	-10–+50°C, derated at temperature higher than 40°C
	Ingress protection (IP) rating	IP20
	Pollution level	Level 2
	Cooling mode	Forced-air cooling
	Brake unit	All series VFDs have built-in brake units.
	Altitude	Below 1000m. When the altitude exceeds 1000m, derate by 1% for every increase of 100m.
	DC reactor	DC reactors have been built in 18.5kW and higher VFD models as standard configuration.
EMC filter	3PH 380V, 5.5kW and higher VFD models fulfill the C3 requirements stipulated in IEC 61800-3, and can connect J10 directly. Other products can use external filters that meet the C3 requirements stipulated in IEC 61800-3. All series products can use external filters that meet the C2 requirements stipulated in IEC 61800-3.	

2.3 Product nameplate

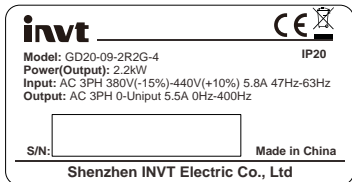

Figure 2-1 Product nameplate

Note: Figure 2-1 shows an example of the Goodrive20-09 product nameplate format. The CE or IP20 marking is put on the nameplate of a product based on the actual certification of the product.

2.4 Model code

The model code includes information about the VFD. You can find the model code from the nameplate on the VFD or from the simplified nameplate.

GD20-09 - 2R2G - 4 - B

① ② ③ ④

Figure 2-2 Product model

Field	Identifier	Description	Example
Product category	①	Product series abbreviation	GD20-09 series VFD for hoisting
Rated power	②	Power range + load type	2R2: 2.2kW; G: Constant-torque load.
Voltage class	③	Voltage class	4: 380 V(-15%) V–440 V(+10%)
Lot No.	④	Brake unit	B: Built-in brake unit Default/None: No built-in brake unit

2.5 Rated specifications

Model	Voltage class	Output power (kW)	Input current (A)	Output current (A)
GD20-09-0R7G-4-B	3PH 380 V	0.75	3.4	2.5
GD20-09-1R5G-4-B		1.5	5.0	4.2
GD20-09-2R2G-4-B		2.2	5.8	5.5
GD20-09-004G-4-B		4	13.5	9.5

Model	Voltage class	Output power (kW)	Input current (A)	Output current (A)
GD20-09-5R5G-4-B		5.5	19.5	14
GD20-09-7R5G-4-B		7.5	25	18.5
GD20-09-011G-4-B		11	32	25
GD20-09-015G-4-B		15	40	32
GD20-09-018G-4-B		18.5	47	38
GD20-09-022G-4-B		22	51	45
GD20-09-030G-4-B		30	70	60
GD20-09-037G-4-B		37	80	75

2.6 Structure diagram

Figure 2-3 shows the structure of the 4kW and lower VFD models (using the 4kW VFD as an example).

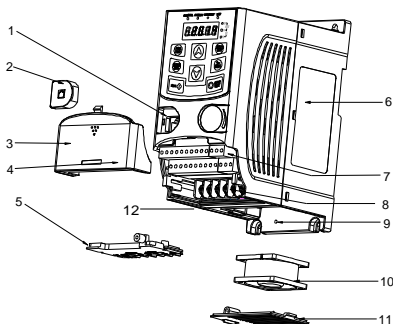

Figure 2-3 Structure diagram of 3PH 380V, 4kW and lower VFD models

SN	Name	Description
1	External keypad port	It is used to connect the external keypad.
2	External keypad port cover	It protects the external keypad port.
3	Sliding cover	It protects the internal parts and components.
4	Knock-down hole for the sliding cover	It is used to fix the sliding cover.
5	Trunking board	It protect the internal parts and components, and fix the cables of the main circuit.

SN	Name	Description
6	Nameplate	See section 2.3 "Product nameplate" for details.
7	Potentiometer knob	See Chapter 5 "Keypad operation".
8	Control terminals	See Chapter 3 "Installation guide" for details.
9	Main circuit terminals	See Chapter 3 "Installation guide" for details.
10	Screw hole for fixing the fan	Fix the fan cover and fan.
11	Cooling fan	See Chapter 7 "Fault tracking" for details.
12	Fan cover	Protect the fan.
13	Bar code	The same as the bar code on the nameplate. Note: The bar code is on the middle shell which is under the lower cover.

Note: In Figure 2-3, the screws at 4 and 9 are provided with packaging, and specific installation depends on the requirements of customers.

Figure 2-4 shows the structure of the VFDs of 5.5kW.

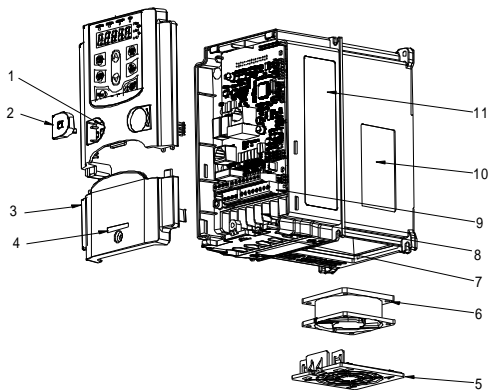

Figure 2-4 Structure diagram of VFDs of 3PH 380 V, 5.5kW

SN	Name	Description
1	External keypad port	It is used to connect the external keypad.
2	External keypad port cover	It protects the external keypad port.

SN	Name	Description
3	Cover	It protects the internal parts and components.
4	Simple nameplate	See section 2.3 "Product nameplate" for details.
5	Fan cover	Protect the fan.
6	Cooling fan	See Chapter 7 "Fault tracking" for details.
7	Bar code	The same as the bar code on the nameplate. Note: The bar code is on the middle shell which is under the lower cover.
8	Main circuit terminals	See Chapter 3 "Installation guide" for details.
9	Control terminals	See Chapter 3 "Installation guide" for details.
10	Nameplate	See section 2.3 "Product nameplate" for details.
11	Film for the heat emission hole	Optional. After the film for the heat emission hole is added, IP rating is increased. It is necessary to derate the VFD because the temperature inside the VFD is increasing.

Figure 2-5 shows the structure of 3PH 380V, 7.5kW and higher VFD models (using the 7.5kW VFD as an example).

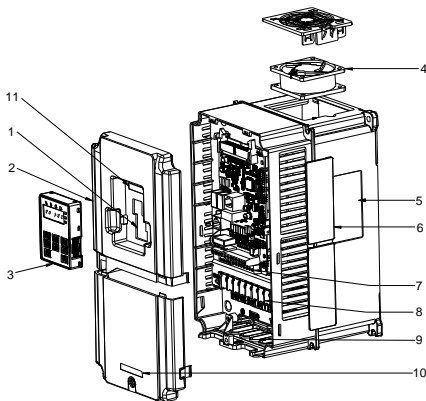



Figure 2-5 Structure diagram of 3PH 380V, 7.5kW and higher VFD models

SN	Name	Description
1	Keypad port	It is used to connect the keypad.
2	Cover	It protects the internal parts and components.
3	Keypad	See Chapter 5 "Keypad operation".
4	Cooling fan	See Chapter 7 "Fault tracking" for details.
5	Nameplate	See section 2.3 "Product nameplate" for details.
6	Cover for the heat emission hole	Optional. After the cover for the heat emission hole is added, IP rating is increased. It is necessary to derate the VFD because the temperature inside the VFD is increasing.
7	Control terminals	See Chapter 3 "Installation guide" for details.
8	Main circuit terminals	See Chapter 3 "Installation guide" for details.
9	The cable entry of the main circuit	It is used to fix the cables of the main circuit.
10	Simple nameplate	See section 2.3 "Product nameplate" for details.
11	Bar code	The same as the bar code on the name plate. Note: The bar code is under the keypad. You can see the bar code through removing the keypad.

3 Installation guide

This chapter describes the mechanical installation and electrical installation of the Goodrive20-09 series VFD.

	<ul style="list-style-type: none"> ◇ Only trained and qualified technicians are allowed to perform mechanical installation. Follow the instructions described in Chapter 1 "Safety precautions". Otherwise, physical injury or death or damage to the devices may be caused. ◇ Ensure the power supply of the VFD is disconnected during the installation. If power is applied to the VFD, wait at least the time specified on it after disconnecting the power supply. ◇ The installation and design of the VFD must comply with the requirements of the local laws and regulations of the installation site. If the installation does not meet the requirements, our company shall not be reliable. In addition, if faults of the VFD are caused due to your neglect of these suggestions, the repair and maintenance will be out of the warranty and quality assurance scope.
--	---

3.1 Mechanical installation

3.1.1 Installation environment

The installation environment is very important to give full play to the performance of the VFD and maintain its functions in long term.

Environmental item	Requirements
Installation site	Indoor.
Ambient temperature	<ul style="list-style-type: none"> ◇ -10°C to +50°C, and the temperature changing rate is less than 0.5°C/minute. ◇ If the ambient temperature is higher than 40°C, derate the machine by 1% for every increased 1°C. ◇ We recommend that you do not use the VFD in environments where the temperature is higher than 50°C (running without load). ◇ To improve the reliability of the machine, do not use it in environments where the temperature changes rapidly. ◇ If the VFD is used in a closed space such as control cabinet, use a cooling fan or cooling air conditioner to lower the temperature inside the space to ensure that the temperature meets the requirement. ◇ If the temperature is too low, an external heating device is required to eliminate the freezing phenomenon when the machine

Environmental item	Requirements
	is started after being powered off for a long time. Otherwise, damage to the machine may be caused.
Humidity	The relative humidity is lower than 90%, and no condensation occurs.
Storage temperature	-30°C to +60°C, and the temperature changing rate is less than 1°C/minute.
Environmental conditions for operation	Install the VFD on a site described as follows: <ul style="list-style-type: none"> ✧ Far away from electromagnetic radiation sources; ✧ Without oil mist, corrosive gas, flammable gas, or other contaminative air; ✧ Keeping foreign objects, such as metal power, dust, oil, and water, from dropping into the VFD (do not install it on the flammable materials such as wood); ✧ Without radioactive and flammable materials; ✧ Without harmful gas or liquid; ✧ With less salt spray; ✧ Without direct sunlight.
Altitude	<ul style="list-style-type: none"> ✧ When the altitude exceeds 1000m, derate by 1% for every increase of 100m; ✧ When the altitude exceeds 3000m, consult the local INVT dealer or office for details.
Vibration	The amplitude cannot exceed 5.8 m/s ² (0.6g).
Installation direction	Install the VFD vertically to ensure the cooling effect.

Note:

The Goodrive20-09 series VFD needs to be installed in a clean and ventilated environment based on the IP level. The cooling air must be clean without corrosive gas or conductive dust.

3.1.2 Installation direction

The VFD can be mounted on a wall or installed in a cabinet.

The VFD must be installed vertically. Check the installation site based on the requirements below. Refer to Appendix B "Dimension drawings" for details.

3.1.3 Installation mode

The 4kW and lower VFD models support wall-mounting and rail installation.

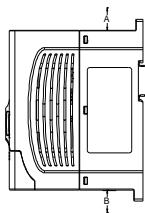

a) Wall mounting

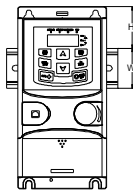

b) Rail installation

Figure 3-1 Installation mode

Note: The minimum length of A and B is 100mm if H is 36.6 mm and W is 35.0mm.

The 5.5kW and higher VFD models support wall-mounting and flange installation.

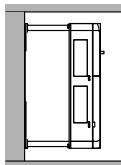

a) Wall-mounting

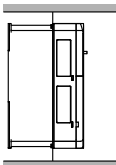

b) Flange installation

Figure 3-2 Installation mode

- (1) Mark the positions of the installation holes. For details about installation holes, refer to Appendix B "Dimension drawings".
- (2) Fix the screws or bolts on the marked positions.
- (3) Hang the VFD on the wall.
- (4) Tighten the holding screws on the wall.

3.2 Standard wiring

3.2.1 Wiring diagram of main circuit

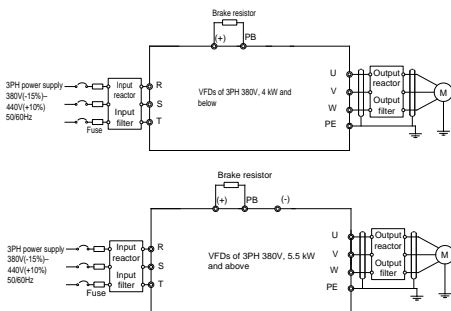

Figure 3-3 Wiring diagram of main circuit

Note:

1. The fuse, braking resistor, input reactor, input filter, output reactor, and output filter are all optional accessories. For details, see Appendix C "Optional peripheral accessories".
2. When the external braking resistor is connected, remove the yellow warning labels marked PB and (+) on the terminal block before connecting the braking resistor wire. Otherwise, poor connection may occur.

3.2.2 Main circuit terminal diagram

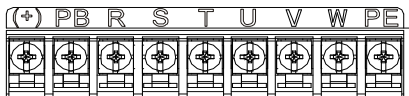

Figure 3-4 Main circuit terminal diagram of 3PH 380V, 4kW and lower VFD models

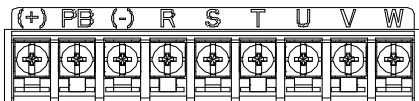

Figure 3-5 Main circuit terminal diagram of 3PH 380V, 5.5–22kW VFD models

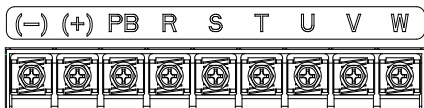

Figure 3-6 Main circuit terminal diagram of 3PH 380V, 30–37kW VFD models

Table 3-1 Function description of main circuit terminals

Terminal symbol	Function description
R, S, T	3PH AC input terminals, connected to the grid.
PB, (+)	PB and (+) are connected to external dynamic braking resistor terminals.
(+), (-)	Brake unit or DC bus input terminal
U, V, W	3PH AC output terminal, usually connected to a motor.
PE	Protective ground terminal. Each machine must be grounded.

Note:

1. Do not use asymmetrically constructed motor cable. If there is a symmetrically constructed ground conductor in the motor cable in addition to the conductive shielding layer, ground the ground conductor at the VFD end and motor end.
2. Lay the motor cable, input power cable, and control cable separately.
3. DC bus circuits of GD series VFDs cannot be connected in parallel with those of CH series VFDs.
4. When DC bus circuits of GD series VFDs are connected in parallel with those of CH series VFDs, the power of these VFDs must be the same, and power-on and power-off shall be conducted simultaneously.
5. For parallel connection of DC bus circuits, current sharing on the input side of the VFD shall be considered during wiring. It is recommended to configure an equalizing reactor.

3.2.3 Wiring of the main circuit terminals

1. Connect the ground wire of the input power cable to the ground terminal (PE) of the VFD. Connect the 3PH input cable to the R, S, and T terminals and tighten them.
2. Connecting the grounding wire of the motor cable to the ground terminal of the VFD. Connect the 3PH motor cable to the U, V, and W terminals, and tighten them.
3. Connect the braking resistor with a cable to the specified position.
4. Fix all the cables outside the VFD mechanically if possible.

3.2.4 Wiring diagram of control circuit

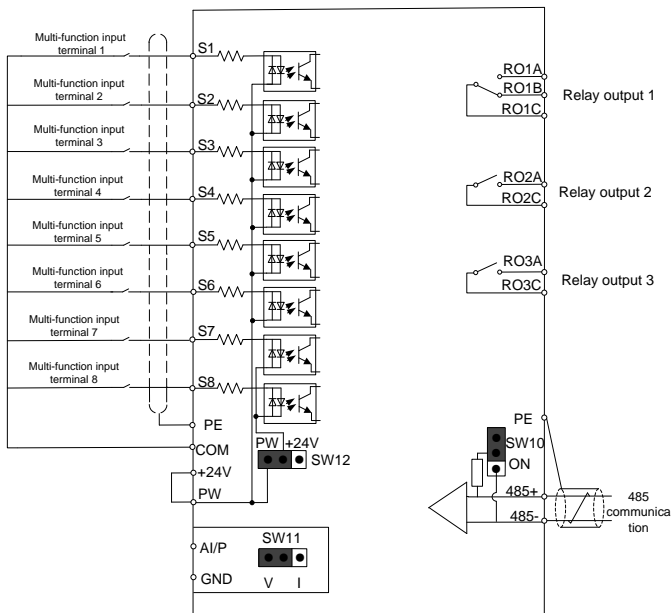

Figure 3-7 Control circuit wiring diagram of 4kW and lower VFD models

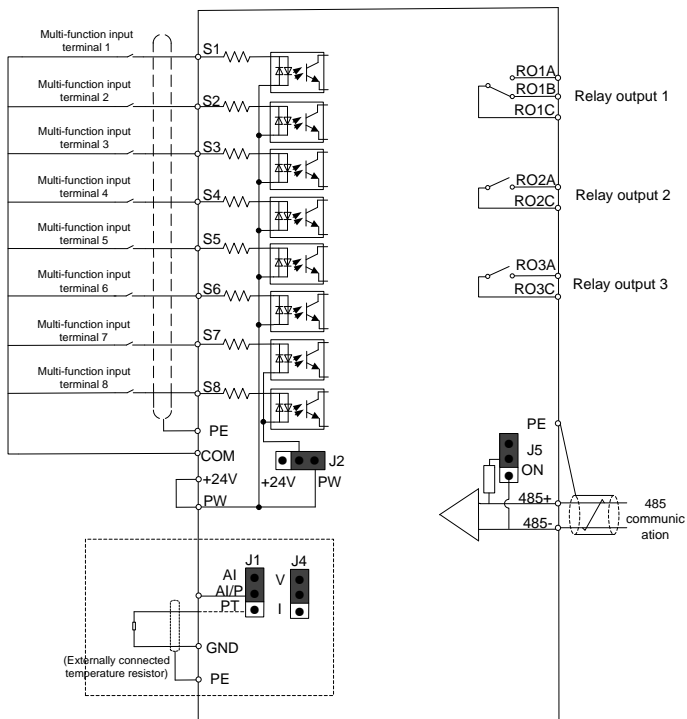

Figure 3-8 Control circuit wiring diagram of 5.5kW-37kW VFD models

3.2.5 Control circuit terminal diagram

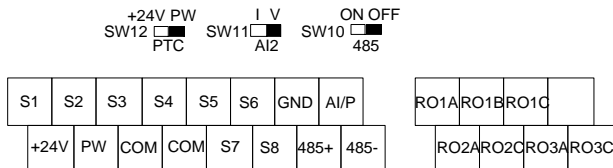

Figure 3-9 Control circuit terminal diagram of 4kW and lower VFD models

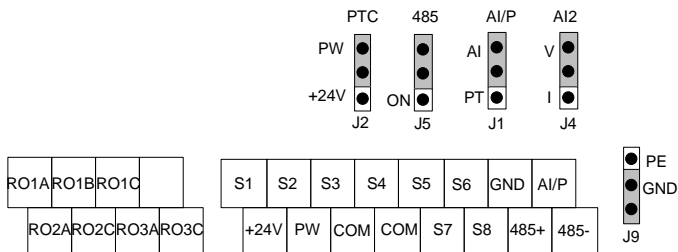

Figure 3-10 Control circuit terminal diagram of 5.5kW–37kW VFD models

Table 3-2 Function description of control circuit terminals

Category	Terminal symbol	Function description	Technical specifications
Analog signal input/output	AI/P	Analog input	<p>The 5.5kW–37kW VFD models select AI2 or PT100 input function through the jumper cap J1. When J1 selects AI position, the terminal function is AI2.</p> <p>The 4kW and lower VFD models are analog input.</p> <ol style="list-style-type: none"> 1. Input range: AI2 voltage and current can be chosen: 0–10 V/0–20mA; 2. Input impedance: 20 kΩ for voltage input, and 500 Ω for current input; 3. Voltage or current input of 5.5kW–37kW VFDs are set by the jumper J4 while voltage

Category	Terminal symbol	Function description	Technical specifications
			<p>or current input of 4kW and below VFDs are set by the DIP switch SW11.</p> <p>4. Resolution: The minimum resolution is 10mV when 10 V corresponds to 50 Hz;</p> <p>5. Detection precision: 1%.</p>
		PT100 input	<p>The 5.5kW–37kW VFD models select AI2 or PT100 input function through the jumper cap J1. When J1 selects PT position, the terminal function is PT100 input.</p> <p>The 4kW and lower VFD models are analog input, and PT100 input function is not configured.</p> <p>1. Resolution: 1°C</p> <p>2. Range: -20°C–150°C</p> <p>3. Detection precision: ±3°C</p> <p>4. Supporting disconnection protection</p>
	GND	Analog reference ground	Analog reference ground
Digital input	S1	Digital input 1	<p>1. Internal impedance: 6 kΩ;</p> <p>2. Supporting external power supply (-20%) 24–48 V DC (+10%), (-10%) 24–48 V AC (+10%) voltage inputs;</p> <p>3. Supporting the internal power supply 24 V;</p> <p>4. These terminals are bi-directional input terminals, supporting both NPN and PNP modes;</p> <p>5. Max. output frequency: 1 kHz.</p> <p>6. All are programmable digital input terminals, the functions of which can be set through function codes</p> <p>S7 and S8 are configured with PTC protection function, refer to PTC wiring diagram for details.</p>
	S2	Digital input 2	
	S3	Digital input 3	
	S4	Digital input 4	
	S5	Digital input 5	
	S6	Digital input 6	
	S7	Digital input 7	
	S8	Digital input 8	
	COM	Digital reference ground	
Communication	485+	485 communication	485 communication terminals, adopting Modbus RTU protocol. Standard 485 communication interface must use twisted shielded pair. Below 4kW VFD models are
	485-		

Category	Terminal symbol	Function description	Technical specifications
			connected to the 120ohm terminal matching resistor of 485 communication through the switch SW10. The 5.5-37kW VFD models are connected to the 120ohm terminal matching resistor of 485 communication through the jumper J5.
Relay output	RO1A	Relay output 1	Relay output RO1; RO1A is in the NO state, RO1B is in the NC state, and RO1C is the common terminal; Contact capacity: 3 A/AC 250 V, 1 A/DC 30 V.
	RO1B		
	RO1C		
	RO2A	Relay output 2	Relay output RO2; RO2A is in the NO state, and RO2C is the common terminal; Contact capacity: 7 A/AC 250 V, 1 A/DC 30 V.
	RO2C		
	RO3A	Relay output 3	Relay output RO3; RO3A is in the NO state, and RO3C is the common terminal; Contact capacity: 3 A/AC 250 V, 1 A/DC 30 V.
RO3C			

3.2.6 Input/output signal connection diagram

(1) 24 V DC input voltage type: Use a U-shaped short-circuit connector to set the NPN or PNP mode and internal or external power supply. NPN internal mode is adopted by default.

(2) 24-48 V AC input voltage type: Wiring according to external power supply (NPN mode) shown in Figure 3-12 or external power supply (PNP mode) shown in Figure 3-13.

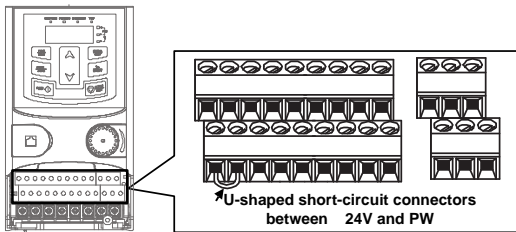

Figure 3-11 U-shaped short-circuit connector

When input signals are transmitted by an NPN transistor, configure the U-shaped short-circuit

connector according to the power supply used, as shown in Figure 3-12.

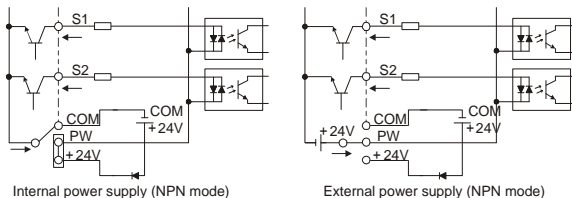

Figure 3-12 NPN mode

When input signals are transmitted by a PNP transistor, configure the U-shaped short-circuit connector according to the power supply used, as shown in Figure 3-13.

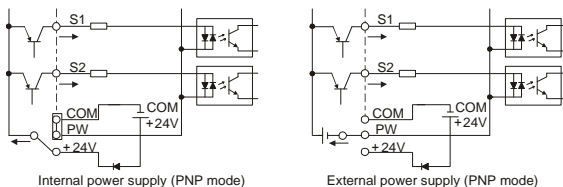

Figure 3-13 PNP mode

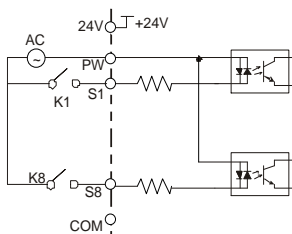

Figure 3-14 AC signal wiring

All channels can be connected to AC signals, and the circuit is consistent with other S parameters. As shown in the above figure, it is necessary to remove the U-shaped short-circuit connector between +24V and PW. One side of the AC power supply is connected to PW while the other side is used as the common terminal of power input.

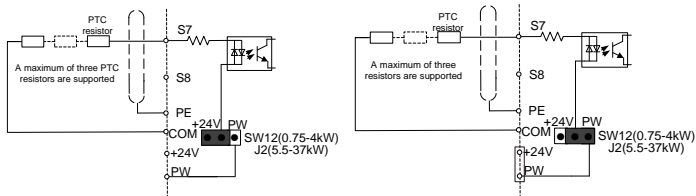

Figure 3-15 PTC wiring

The PTC resistor is connected between S7 and COM. The two ways to use the external and internal jumpers are shown in above figures, and the selection depends on the usage shown in Figure 3.12, Figure 3.13, and Figure 3.14. P05.07 selects 71 PTC overtemperature valid signal to enable, and P27.20 can set this signal as alarm or fault signal.

When the PTC resistor is connected between S8 and COM, the two ways to use the external and internal jumpers are shown in above figures, and the selection depends on the usage shown in Figure 3.12, Figure 3.13, and Figure 3.14. P05.08 selects 71 PTC overtemperature valid signal to enable, and P27.20 can set this signal as alarm or fault signal. S7 and S8 cannot use PTC overtemperature valid signal function simultaneously.

As for the brand model of PTC, refer to Appendix C.9 "Recommended PTC model selection".

3.3 Wiring protection

3.3.1 Protect the VFD and input power cable when a short circuit occurs

When a short circuit occurs, protect the VFD and input power cable to prevent thermal overload. Implement protection through the wiring shown in Figure 3-16.

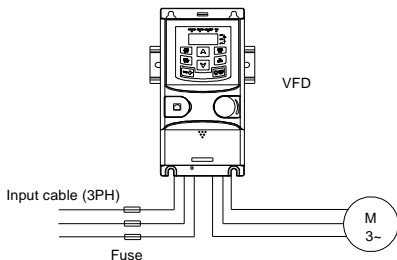

Figure 3-16 Fuse configuration

Note: Select the fuse as described in the manual. When a short circuit occurs, the fuse protects the input power cable to prevent damage to the VFD. When a short circuit occurs inside the VFD, the fuse prevents damage to the adjacent devices of the VFD.

3.3.2 Protect the motor and motor cable

If the motor cable is selected based on the rated current of the VFD, the VFD can protect the motor cable and motor when a short circuit occurs. The VFD provides the motor thermal overload protection function, which can protect the motor, and lock the output and cut off the current when necessary.



⚡ If multiple motors are connected to the VFD, you need to use separate thermal overload switches or breakers to protect the motor cables and motors. Fuses may be required to cut off short-circuit current for these devices.

3.3.3 Establish a bypass connection

In general, some important scenarios may require the setting of switching between the variable frequency and power frequency modes to ensure the proper operation of the system when a fault occurs on the VFD. For some special scenarios, such as soft start-only scenarios where the system can directly switch to the power frequency operation mode after being started, you also need to configure a bypass link.



⚡ Do not connect the power supply to the output terminals U, V, and W of the VFD. The voltage fed to the motor cable may cause permanent damage to the VFD.

If frequency switching is required, you can use a mechanical interlock switch or contactor to ensure that the motor terminals are not simultaneously connected to the input power cable and the output terminal of the VFD.

4 Commissioning guide

4.1 Commissioning lifting in open-loop vector control

4.1.1 Wiring

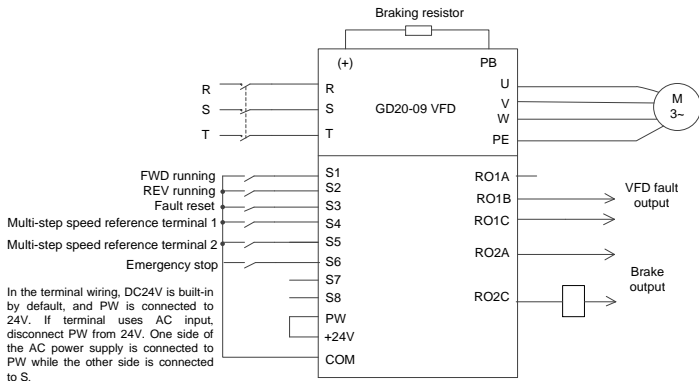

Figure 4-1 Wiring for open-loop vector control

Note: If the wiring is performed according to Figure 4-1, most VFD parameters need no adjustment. If the onsite function terminals are inconsistent with the terminals shown in the figure, manually adjust the input and output terminal functions according to the actual wiring after selecting the open-loop vector controlled lifting application macro.

4.1.2 Commissioning procedure

1. Check the wiring and ensure the wiring is proper.
2. Set P00.18=1 (Restoring to the default values indicates that P19.00=1, namely open-loop vector controlled lifting application macro).
3. Set motor parameters in P02 group.
4. Set P00.15=2. The keypad displays "-ГUN-". Press the RUN key to perform static autotuning (To perform the rotary autotuning, it is necessary to set P19.00=0: Common mode first. Set P00.15=1. The keypad displays "- ГUN-". Press the RUN key to perform rotary autotuning).
5. Set P19.00=1 to select the open-loop vector controlled lifting function macro.
6. Perform low-speed trial running.

4.1.3 Macro parameters (P19.00=1)

Function code	Name	Setting	Remarks
P00.00	Speed control mode	1	SVC 1
P00.01	Channel of running commands	1	Terminals
P00.03	Max. output frequency	100.00 Hz	
P00.04	Upper limit of running frequency	90.00 Hz	
P00.06	Setting channel of A frequency command	6	Multi-step speed reference
P00.11	ACC time 1	8.0 s	
P00.12	DEC time 1	8.0 s	
P01.01	Starting frequency of direct start	1.00 Hz	
P01.15	Stop speed	1.50 Hz	
P05.03	Function of S3 terminal	7	Fault reset
P05.04	Function of terminal S4	16	Multi-step speed reference terminal 1
P05.05	Function of terminal S5	17	Multi-step speed reference terminal 2
P05.06	Function of terminal S6	6	Emergency stop
P06.03	Relay RO1 output	5	VFD fault
P06.04	Relay RO2 output	38	Brake output
P10.02	Multi-step speed 0	10.0%	Relative to the max. output frequency (P00.03)
P10.04	Multi-step speed 1	25.0%	Relative to the max. output frequency (P00.03)
P10.06	Multi-step speed 2	50.0%	Relative to the max. output frequency (P00.03)
P10.08	Multi-step speed 3	50.0%	Relative to the max. output frequency (P00.03)
P11.08	VFD/motor overload/underload pre-alarm setting	0x021	Enable underload protection to improve device security
P19.01	Brake control	1	Brake is controlled by the VFD
P19.17	Reverse brake closing frequency	3.50 Hz	
P19.18	Delay before brake release	0.000 s	
P19.19	Delay after brake release for forward running	0.500 s	
P19.20	Delay after brake release for reverse-running start	0.500 s	

Function code	Name	Setting	Remarks
P19.21	Delay before brake closing at stop	0.000 s	
P19.22	Delay after brake closing at stop	0.100 s	
P19.26	Torque verification fault detection time	2.000 s	
P19.27	Forward brake release torque	50.0%	Corresponding to rated torque of the motor
P19.28	Reverse brake release torque	30.0%	Corresponding to rated torque of the motor

Note: If S terminal uses the AC power supply, it is necessary to perform wiring according to the AC wiring mode. After setting up the application macro, it is necessary to set P27.13=1. Some parameters are factory default parameters, which are not be listed in the application macro parameter table. If S terminal selects functions 61–65 Graded reference terminals, set the P19.06–P19.11 group Graded speed reference according to section 4.7 "Commissioning graded reference operating lever application" in Chapter 4 "Commissioning guide". If S terminal selects the fast stop function, it is necessary to set P08.05 (Fast stopping time). If brake feedback is selected as terminal function, it is necessary to set the function macro before setting the brake feedback function.

4.1.4 Points for attention

1. If you only want to check whether the VFD runs properly, set P19.00=0 (Common mode).
2. If you perform empty-load commissioning, set P19.00 to 1 (Lifting in open-loop vector control), set P11.08 to 0x000 to disable underload protection, and set P19.27 and P19.28 to 0 to prevent the torque verification fault reporting caused by empty load. In addition, if no external braking resistor is connected, you need to increase the ACC/DEC time to prevent the bus overvoltage fault reporting caused by too fast stop.
3. During onsite commissioning, if the VFD terminal signal upward/downward running command is inconsistent with the load lifting/lowering direction, adjust any two phase sequences of VFD output terminals U, V, and W but not change the value of P00.13.
4. If PLC control is used, speed signal and other input and output signal functions need to be adjusted according to the actual control logic.
5. This macro can meet the requirements of most lifting application cases, and the performance parameters have been optimized and do not need to be adjusted in most cases. If an exception occurs, see the function parameter chapter for adjustment or contact the technical support.

4.2 Commissioning lifting in space voltage vector control

4.2.1 Wiring

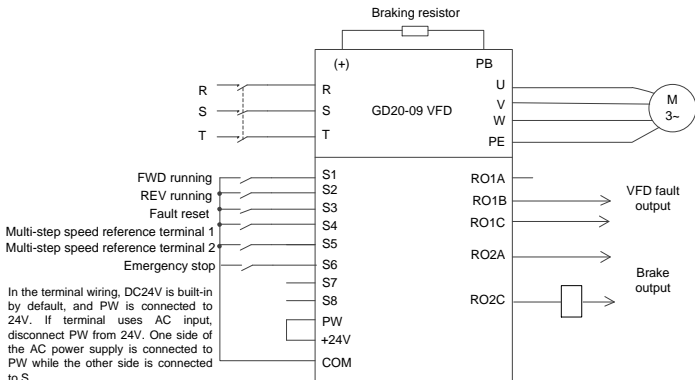

Figure 4-2 Wiring for lifting in space voltage vector control

Note: If the wiring is performed according to Figure 4-2, most VFD parameters need no adjustment. If the onsite function terminals are inconsistent with the terminals shown in the figure, manually adjust the input and output terminal functions according to the actual wiring after selecting the space voltage vector controlled lifting application macro.

4.2.2 Commissioning procedure

1. Check the wiring and ensure the wiring is proper.
2. Set P00.18=1 to restore to the factory settings (Restoring to the default values indicates that P19.00=1, namely open-loop vector controlled lifting application macro).
3. Set motor parameters in P02 group.
4. Set P19.00=2 to select the space voltage vector controlled lifting function macro.
5. Perform low-speed trial running.

4.2.3 Macro parameters (P19.00=2)

Function code	Name	Setting	Remarks
P00.00	Speed control mode	2	Space Vector Pulse Width Modulation (SVPWM)

Function code	Name	Setting	Remarks
P00.01	Channel of running commands	1	Terminals
P00.03	Max. output frequency	100.00Hz	
P00.04	Upper limit of running frequency	90.00Hz	
P00.06	Frequency A command	6	Multi-step speed reference
P00.11	ACC time 1	8.0s	
P00.12	DEC time 1	8.0s	
P05.03	Function of terminal S3	7	Fault reset
P05.04	Function of terminal S4	16	Multi-step speed reference terminal 1
P05.05	Function of terminal S5	17	Multi-step speed reference terminal 2
P05.06	Function of terminal S6	6	Emergency stop
P06.03	Relay RO1 output	5	VFD fault
P06.04	Relay RO2 output	38	Brake output
P10.02	Multi-step speed 0	10.0%	Relative to the max. output frequency (P00.03)
P10.04	Multi-step speed 1	25.0%	Relative to the max. output frequency (P00.03)
P10.06	Multi-step speed 2	50.0%	Relative to the max. output frequency (P00.03)
P10.08	Multi-step speed 3	50.0%	Relative to the max. output frequency (P00.03)
P11.08	VFD/motor overload/underload pre-alarm setting	0x021	Enable underload protection to improve device security
P19.01	Brake control	1	Brake is controlled by the VFD
P19.12	Forward brake release frequency	3.00Hz	
P19.13	Forward brake release current	50.0%	Corresponding to rated current of the motor
P19.14	Forward brake closing frequency	3.00Hz	
P19.15	Reverse brake release frequency	3.00Hz	
P19.16	Reverse brake release current	50.0%	Corresponding to rated current of the motor
P19.17	Reverse brake closing frequency	3.00Hz	

Note: If S terminal uses the AC power supply, it is necessary to perform wiring according to the AC wiring mode. After setting up the application macro, it is necessary to set P27.13=1. Some parameters are factory default parameters, which are not be listed in the application macro parameter table. If S terminal selects functions 61–65 Graded speed reference, set the P19.06–P19.11 group Graded speed reference according to section 4.7 "Commissioning graded reference operating lever application" in Chapter 4 "Commissioning guide". If S terminal selects the fast stop function, it is necessary to set P08.05 (Fast stopping time). If brake feedback is selected as terminal function, it is necessary to set the function macro before setting the brake feedback function.

4.2.4 Points for attention

1. If you only want to check whether the VFD runs properly, set P19.00=0(Common mode).
2. If you perform empty-load commissioning, set P19.00 to 2 (Lifting in space voltage vector control), set P11.08 to 0x000 to disable underload protection, and set P19.13 and P19.16 to 0 to prevent the torque verification fault reporting caused by empty load. In addition, if no external braking resistor is connected, you need to increase the ACC/DEC time to prevent the bus overvoltage fault reporting caused by too fast stop.
3. During onsite commissioning, if the VFD terminal signal upward/downward running command is inconsistent with the load lifting/lowering direction, adjust any two phase sequences of VFD output terminals U, V, and W but not change the value of P00.13.
4. If PLC control is used, speed signal and other input and output signal functions need to be adjusted according to the actual control logic.
5. This macro can meet the requirements of most lifting application cases, and the performance parameters have been optimized and do not need to be adjusted in most cases. If an exception occurs, see the function parameter chapter for adjustment or contact the technical support.

4.3 Commissioning horizontal moving

4.3.1 Wiring

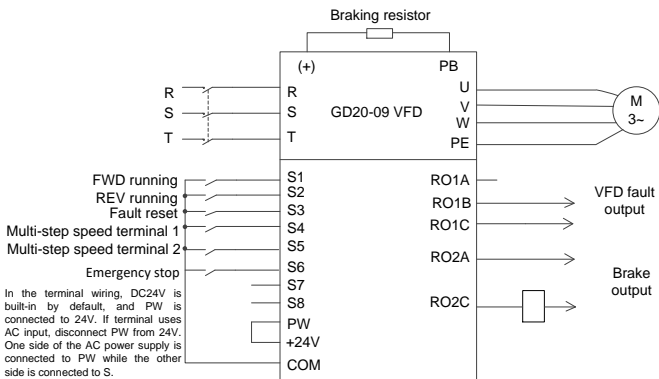

Figure 4-3 Wiring for horizontal moving

Note: If the wiring is performed according to Figure 4-3, most VFD parameters need no adjustment. If the onsite function terminals are inconsistent with the terminals shown in the figure, manually adjust the input and output terminal functions according to the actual wiring after selecting the horizontal moving application macro.

4.3.2 Commissioning procedure

1. Check the wiring and ensure the wiring is proper.
2. Set P00.18=1 (Restoring to the default values indicates that P19.00=1, namely open-loop vector controlled lifting application macro).
3. Set motor parameters in P02 group.
4. Set P19.00=3 to select the horizontal moving function macro.
5. Perform low-speed trial running.

4.3.3 Macro parameters (P19.00=3)

Function code	Name	Setting	Remarks
P00.00	Speed control mode	2	Space Vector Pulse Width Modulation (SVPWM)
P00.01	Channel of running	1	Terminals

Function code	Name	Setting	Remarks
	commands		
P00.03	Max. output frequency	100.00Hz	
P00.04	Upper limit of running frequency	60.00Hz	
P00.06	Frequency A command	6	Multi-step speed reference
P00.11	ACC time 1	5.0s	
P00.12	DEC time 1	4.0s	
P01.01	Starting frequency of direct start	0.20Hz	
P01.15	Stop speed	0.10 Hz	
P05.03	Function of terminal S3	7	Fault reset
P05.04	Function of terminal S4	16	Multi-step speed terminal 1
P05.05	Function of terminal S5	17	Multi-step speed terminal 2
P05.06	Function of terminal S6	6	Emergency stop
P06.03	Relay RO1 output	5	VFD fault
P06.04	Relay RO2 output	38	Brake output
P10.02	Multi-step speed 0	10.0%	Relative to the max. output frequency (P00.03)
P10.04	Multi-step speed 1	30.0%	Relative to the max. output frequency (P00.03)
P10.06	Multi-step speed 2	50.0%	Relative to the max. output frequency (P00.03)
P10.08	Multi-step speed 3	50.0%	Relative to the max. output frequency (P00.03)
P11.05	Current limiting setting	0x11	Enable software current limiting
P19.01	Brake control	1	Brake is controlled by the VFD
P19.13	Forward brake release current	50.0%	Corresponding to rated current of the motor
P19.16	Reverse brake release current	50.0%	Corresponding to rated current of the motor

Note: If S terminal uses the AC power supply, it is necessary to perform wiring according to the AC wiring mode. After setting up the application macro, it is necessary to set P27.13=1. Some parameters are factory default parameters, which are not be listed in the application macro parameter table. If S terminal selects functions 61–65 Graded speed reference, set the

P19.06–P19.11 group Graded speed reference according to section 4.7 "Commissioning graded reference operating lever application" in Chapter 4 "Commissioning guide". If S terminal selects the fast stop function, it is necessary to set P08.05 (Fast stopping time). If brake feedback is selected as terminal function, it is necessary to set the function macro before setting the brake feedback function.

4.3.4 Points for attention

1. If you only want to check whether the VFD runs properly, set P19.00=0(Common mode).
2. If you perform empty-load commissioning, set P19.00 to 3 (Horizontal moving application mode), and set P19.13 and P19.16 to 0 to prevent the torque verification fault reporting caused by empty load. In addition, if no external braking resistor is connected, you need to increase the ACC/DEC time to prevent the bus overvoltage fault reporting caused by too fast stop.
3. During onsite commissioning, if the VFD terminal signal upward/downward running command is inconsistent with the load lifting/lowering direction, adjust any two phase sequences of VFD output terminals U, V, and W but not change the value of P00.13.
4. If PLC control is used, speed signal and other input and output signal functions need to be adjusted according to the actual control logic.
5. This macro can meet the requirements of most lifting application cases, and the performance parameters have been optimized and do not need to be adjusted in most cases. If an exception occurs, see the function parameter chapter for adjustment or contact the technical support.

4.4 Commissioning the conical motor function

4.4.1 Wiring

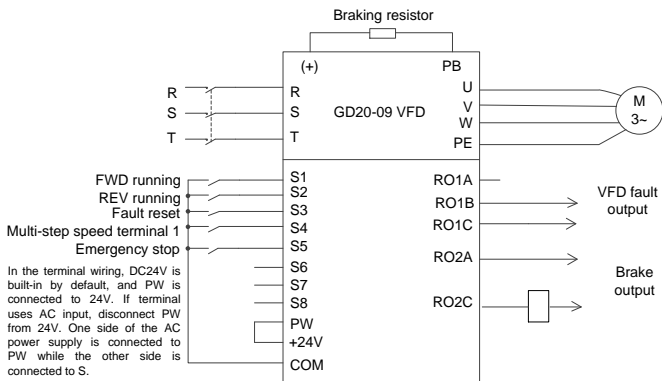

Figure 4-4 Wiring for the conical motor

Note: If the wiring is performed according to Figure 4-4, most VFD parameters need no adjustment. If the onsite function terminals are inconsistent with the terminals shown in the figure, manually adjust the input and output terminal functions according to the actual wiring after selecting the conical motor application macro.

4.4.2 Commissioning procedure

1. Check the wiring and ensure the wiring is proper.
2. Set P00.18=1 (Restoring to the default values indicates that P19.00=1, namely open-loop vector controlled lifting application macro).
3. Set motor parameters in P02 group.
4. Set P19.00=5 to select the conical motor function macro.
5. Perform low-speed trial running.

4.4.3 Macro parameters (P19.00=5)

Table 4-1 Parameter settings

Function code	Name	Setting	Remarks
P00.00	Speed control mode	2	Space Vector Pulse Width Modulation (SVPWM)
P00.01	Channel of running commands	1	Terminals
P00.06	Frequency A command	6	Multi-step speed running
P00.11	ACC time 1	3	Time taken to accelerate from 0Hz to the max. frequency
P00.12	DEC time 1	2	Time taken to decelerate from the max. frequency to 0Hz
P01.01	Start frequency at direct start	2.00	2.00Hz
P05.03	Function of terminal S3	7	Fault reset
P05.04	Function of terminal S4	16	Multi-step speed terminal 1
P05.05	Function of terminal S5	6	Emergency stop
P06.03	Relay RO1 output	5	故障输出 VFD fault
P10.02	Multi-step speed 0	50.0%	50% of the max. output frequency (P00.03)
P10.04	Multi-step speed 1	100.0%	100% of the max. output frequency (P00.03)
P19.02	Conical motor function enabling	1	Enable

Note: If S terminal uses the AC power supply, it is necessary to perform wiring according to the AC wiring mode. After setting up the application macro, it is necessary to set P27.13=1. Some parameters are factory default parameters, which are not be listed in the application macro parameter table. If S terminal selects functions 61–65 Graded speed reference, set the P19.06–P19.11 group Graded speed reference according to section 4.7 "Commissioning graded reference operating lever application" in Chapter 4 "Commissioning guide".

4.4.4 Points for attention

1. If you only want to check whether the VFD runs properly, set P19.00=0(Common mode).
2. If the direction is incorrect when the heavy load runs upward during lifting in forward running mode, adjust any two phase sequences of VFD output terminals U, V, and W but not change the value of P00.13.
3. The starting frequency cannot be set too low. During onsite commissioning, ensure the starting frequency is set properly so that the brake can be turned on, and ensure the

brake has been turned on before running.

4. The lifting ACC time can be 3s at most. If the ACC time is too long, the brake may not be opened.
5. The rated voltage must be at least 380V. If the grid rated voltage is too low (lower than 85% U_e), the brake cannot be opened; if the voltage is too low, the speed cannot be boosted.
6. When the conical motor performs constant-power variable-frequency speed regulation (boost), the max. rotating speed cannot exceed 1.2 times the rated speed (60Hz). Otherwise, the motor cannot run properly since the pressure spring cannot be pushed due to the axial magnetic pull force reduce, and therefore the VFD encounters the current limit or overcurrent fault.

4.5 Commissioning the brake function

4.5.1 Commissioning brake

1. Set P19.01 to 1 to enable the brake function.
2. Set relay brake output. If RO2 is connected to the braking contactor, set P06.04 to 38.
3. If the brake contactor has the feedback function, connect the brake feedback wire to an input terminal, for example, S3. Then set P05.03 to 59 indicating brake feedback signal. After the brake is opened, if S3 cannot detect the brake feedback signal, a brake feedback fault (FAE) is reported when the brake feedback delay is reached.
4. In lifting application, if you enable the I/F function, set P04.36 to a non-zero value, set P04.38, and set P04.39 in space voltage vector control mode, you can choose whether to enable the I/F function in horizontal moving application.
5. In space voltage vector control model, set P19.13 and P19.16 (set P19.27 and P19.28 in open-loop vector control mode) to ensure there is enough torque before the brake is opened.
6. Set the brake timing sequence, including the forward/reverse brake release frequency, forward/reverse brake closing frequency, delay before brake release (T1), delay after forward brake release (T2), delay after reverse brake release (T3), delay before brake closing (T4), and delay after brake closing (T5).
7. Perform trial running and check whether the brake timing sequence is correct. The brake timing sequence diagram is shown as follows:

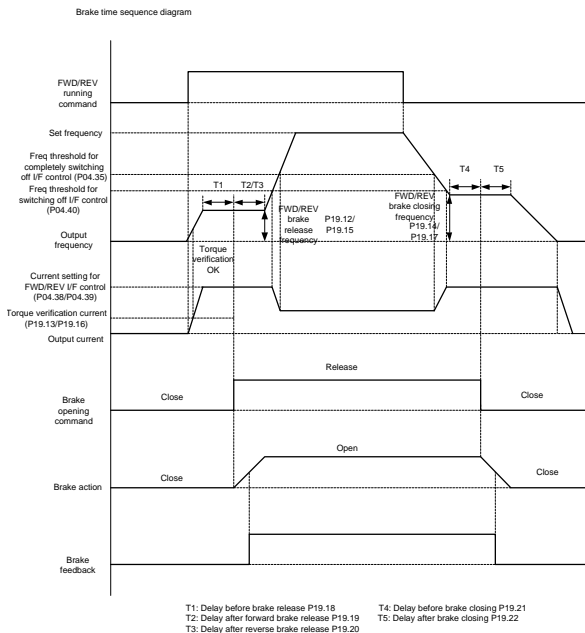

8. Adjust braking comfortability, which can be implemented by using the following methods.

A. In I/F mode, you can decrease the brake release frequency and brake closing frequency and adjust the T1–T5 delay parameters in the timing sequence so that the impact is reduced. Note that the brake release frequency and brake closing frequency are greater than P01.01 (Starting frequency) and P01.15 (Stop speed) in most cases.

B. During the reverse-running stop, you can apply the forward torque, that is, for reverse-running start, you can perform forward brake release and then perform reverse running; for reverse-running stop, you can switch reverse running to forward running, close the brake, and then perform forward-running stop. This ensures there is no slip is felt during reverse start or stop. Forward torque is enabled by setting P19.35 and P19.36.

C. During the stop process, you can enable the maintenance frequency so that the device runs at a low speed within a small period of time before the stop, since impact may be caused

if the device directly stops at a high speed. The maintenance frequency for stop can be enabled by setting P19.46 to a non-zero value. You can set the maintenance frequency through P19.45.

The timing sequence is as follows:

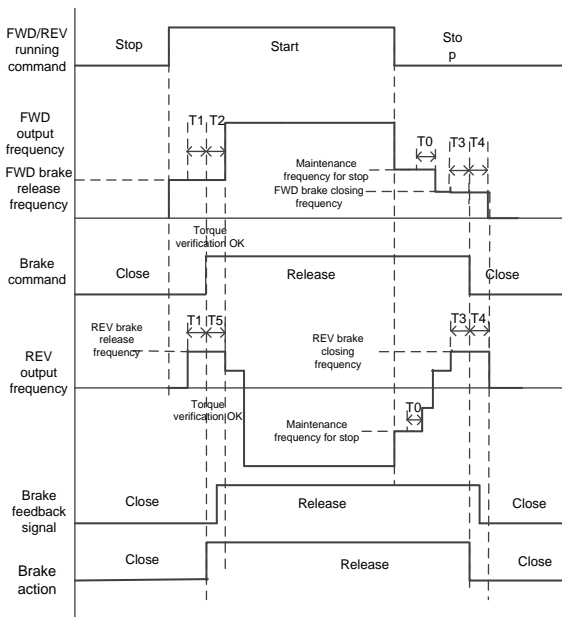

T1: Delay before brake release P19.18

T3: Delay before brake closing P19.21

T2: Delay after forward brake release P19.19

T4: Delay after brake closing P19.22

T5: Delay after reverse brake release P19.20

T0: Maintenance frequency hold time for stop P19.46

D. If two segments of ACC/DEC time are used, you can increase ACC/DEC time at low frequency running to ensure smoothness at low-frequency start or stop. You can set P19.44 (Frequency threshold for switching ACC/DEC time) to a non-zero value to enable two segments of ACC/DEC time, and then the ACC/DEC time 1 (P00.11 and P00.12) and ACC/DEC time 2 (P08.00 and P08.01) are used.

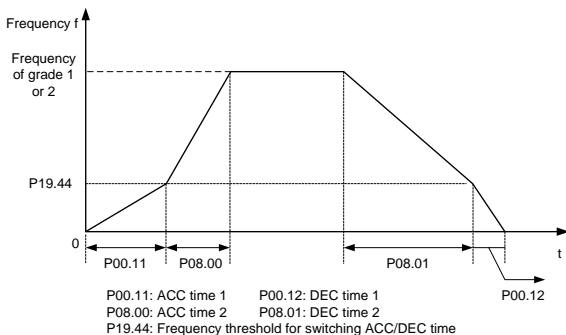

4.5.2 Torque verification

When the VFD starts and the brake is in closing state, torque verification timing starts, and the VFD output current (output torque) is detected simultaneously. If the VFD output current or torque is greater than the set value of torque verification current (torque verification torque) ($P19.13$ and $P19.16$ or $P19.27$ and $P19.28$), torque verification starts and lasts for 60ms, torque verification succeeds. If torque verification does not pass after the torque verification fault detection time ($P19.26$) is reached, the torque verification fault tPF is reported.

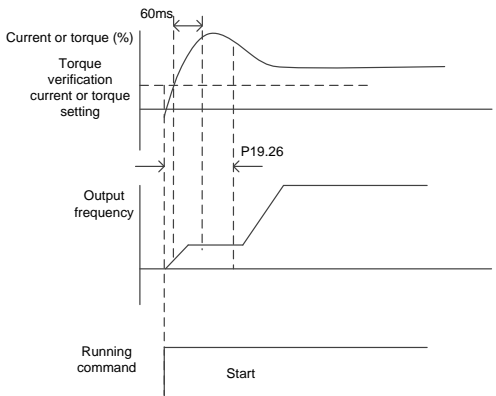

4.5.3 Commissioning parameters

Function code	Name	Detailed description	Default value
P19.01	Brake control	0–1 0: Do not control the brake 1: Brake is controlled by the VFD	0
P19.12	Forward brake release frequency	0.00–20.00Hz	3.00
P19.13	Forward brake release current	0.0–200.0% (of the rated current of the motor)	0.0%
P19.14	Forward brake closing frequency	0.00–20.00Hz	3.00
P19.15	Reverse brake release frequency	0.00–20.00Hz	3.00
P19.16	Reverse brake release current	0.0–200.0% (of the rated current of the motor)	0.0%
P19.17	Reverse brake closing frequency	0.00–20.00Hz	2.50
P19.18	Delay before brake release	0.000–5.000s	0.300s
P19.19	Delay after brake release for forward running	0.000–5.000s	0.150s
P19.20	Delay after brake release for reverse running	0.000–5.000s	0.150s
P19.21	Delay before brake closing at stop	0.000–5.000s	0.150s
P19.22	Delay after brake closing at stop	0.000–5.000s	0.300s
P19.24	Brake feedback detection time	0.00–20.000s	1.000s
P19.26	Torque verification fault detection time	0.00–10.000s	3.000s
P19.27	Forward brake release torque	0.0–200.0% (of the rated torque of the motor)	0.0%
P19.28	Reverse brake release torque	0.0–200.0% (of the rated torque of the motor)	0.0%
P19.35	Reverse-running start	0: The reverse-running start direction	0

Function code	Name	Detailed description	Default value
	direction	complies with the running direction 1: The reverse-running start direction is always the forward-running direction	
P19.36	Reverse-running stop direction	0: The reverse-running stop direction complies with the running direction 1: The reverse-running stop direction is always the forward-running direction	0
P19.41	Brake selection for forward/reverse switchover	0: Perform switchover without braking 1: Perform switchover with braking	0
P19.42	Restart selection during braking	0: No restart during braking 1: Restart allowed during braking	0
P19.43	Wait time of restart	0.0–10.0s	0.5s
P19.44	Frequency threshold for switching ACC/DEC time	0.00–50.00Hz	0.00Hz
P19.45	Hold frequency during the forward torque deceleration	0.00–50.00Hz	5.00Hz
P19.46	Hold time for frequency maintained during the forward torque deceleration	0.00–5.000s	0.000s

4.6 Commissioning analog reference operating lever

4.6.1 Wiring

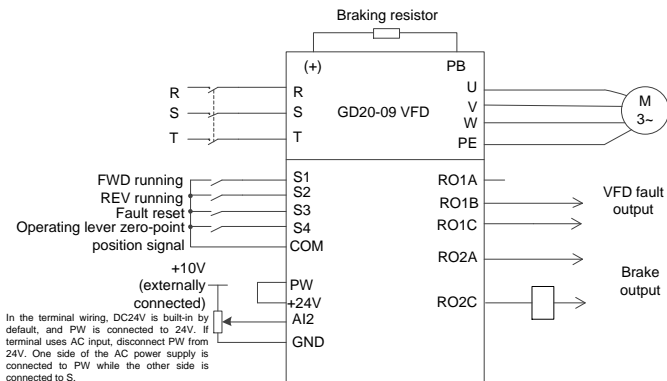

Figure 4-5 Wiring for analog reference operating lever

Note: Perform the wiring according to Figure 4-5. If the onsite function terminals are inconsistent with the terminals shown in the figure, manually adjust the input and output terminal functions according to the actual wiring (select 0–10V for operating lever analog).

4.6.2 Commissioning procedure

1. Check the wiring and ensure the wiring is proper.
2. Set P00.18=1 (Restoring to the default values indicates that P19.00=1, namely open-loop vector controlled lifting application macro).
3. Set motor parameters in P02 group.
4. Set the function macro to be applied, and perform the wiring according to the wiring diagram, and set parameters of the analog reference operating lever application.
5. Perform low-speed trial running.

4.6.3 Application parameters

Function code	Name	Setting	Remarks
P00.01	Channel of running commands	1	1: Terminals
P00.06	Frequency A command	2	2: AI2 (terminal)
P05.03	Function of terminal S3	7	7: Fault reset

Function code	Name	Setting	Remarks
P05.04	Function of terminal S4	60	60: Operating lever zero-point position signal
P05.37	Lower limit of AI2	0.00V	0.00V - P05.39
P05.38	Setting corresponding to lower limit of AI2	0.0%	-100.0% - 100.0%
P05.39	Upper limit of AI2	10.00V	P05.37 - 10.00V
P05.40	Setting corresponding to upper limit of AI2	100.0%	-100.0% - 100.0%
P05.41	AI2 input filtering time	0.100s	0.000s - 10.000s

Note: If S terminal uses the AC power supply, it is necessary to perform wiring according to the AC wiring mode. After setting up the application parameters, it is necessary to set P27.13=1. Some parameters are factory default parameters, which are not be listed in the parameter table.

4.6.4 Points for attention

1. If you only want to check whether the VFD runs properly, set P19.00=0(Common mode).
2. If you perform empty-load commissioning, it is necessary to set the parameters according to the commissioning steps. If P19.13 and P19.16 (P19.27 and P19.28) are set to non-zero values, you need to set P19.13 and P19.16 (P19.27 and P19.28) to 0 to prevent the torque verification fault reporting caused by empty load. In addition, if no external braking resistor is connected, you need to increase the ACC/DEC time to prevent the bus overvoltage fault reporting caused by too fast stop.
3. During onsite commissioning, if the VFD terminal signal upward/downward running command is inconsistent with the load lifting/lowering direction, adjust any two phase sequences of VFD output terminals U, V, and W but not change the value of P00.13.
4. The application parameters can meet the requirements of most analog operating lever application cases, and do not need to be adjusted in most cases. If an exception occurs, see the function parameter chapter for adjustment or contact the technical support.

4.7 Commissioning graded reference operating lever

4.7.1 Wiring

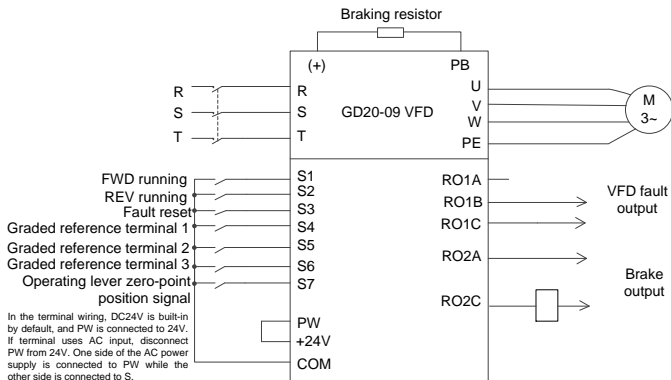

Figure 4-6 Wiring for graded reference operating lever

Note: Perform the wiring according to Figure 4-6. If the onsite function terminals are inconsistent with the terminals shown in the figure, manually adjust the input and output terminal functions according to the actual wiring.

4.7.2 Commissioning procedure

1. Check the wiring and ensure the wiring is proper.
2. Set P00.18=1 (Restoring to the default values indicates that P19.00=1, namely open-loop vector controlled lifting application macro).
3. Set motor parameters in P02 group.
4. Set the function macro to be applied, and perform the wiring according to the wiring diagram, and set parameters of the graded reference operating lever application.
5. Perform low-speed trial running.

4.7.3 Application parameters

Function code	Name	Setting	Remarks
P00.01	Channel of running commands	1	1: Terminals
P00.06	Frequency A command	13	13: Graded multi-step speed reference
P05.03	Function of terminal S3	7	7: Fault reset

Function code	Name	Setting	Remarks
P05.04	Function of terminal S4	61	61: Graded reference terminal 1
P05.05	Function of terminal S5	62	62: Graded reference terminal 2
P05.06	Function of terminal S6	63	63: Graded reference terminal 3
P05.07	Function of terminal S7	60	60: Operating lever zero-point position signal
P19.06	Graded multi-step speed reference 0	10.0%	Relative to the max. output frequency (P00.03)
P19.07	Graded multi-step speed reference 1	20.0%	Relative to the max. output frequency (P00.03)
P19.08	Graded multi-step speed reference 2	30.0%	Relative to the max. output frequency (P00.03)
P19.09	Graded multi-step speed reference 3	50.0%	Relative to the max. output frequency (P00.03)

Note: If S terminal uses the AC power supply, it is necessary to perform wiring according to the AC wiring mode. After setting up the application parameters, it is necessary to set P27.13=1. Some parameters are factory default parameters, which are not be listed in the parameter table.

4.7.4 Points for attention

1. If you only want to check whether the VFD runs properly, set P19.00=0(Common mode).
2. If you perform empty-load commissioning, it is necessary to set the parameters according to the commissioning steps. If P19.13 and P19.16 (P19.27 and P19.28) are set to non-zero values, you need to set P19.13 and P19.16 (P19.27 and P19.28) to 0 to prevent the torque verification fault reporting caused by empty load. In addition, if no external braking resistor is connected, you need to increase the ACC/DEC time to prevent the bus overvoltage fault reporting caused by too fast stop.
3. During onsite commissioning, if the VFD terminal signal upward/downward running command is inconsistent with the load lifting/lowering direction, adjust any two phase sequences of VFD output terminals U, V, and W but not change the value of P00.13.
4. The application parameters can meet the requirements of most graded reference operating lever application cases, and do not need to be adjusted in most cases. If an exception occurs, see the function parameter chapter for adjustment or contact the technical support.

4.8 Commissioning multi-step speed reference

4.8.1 Wiring

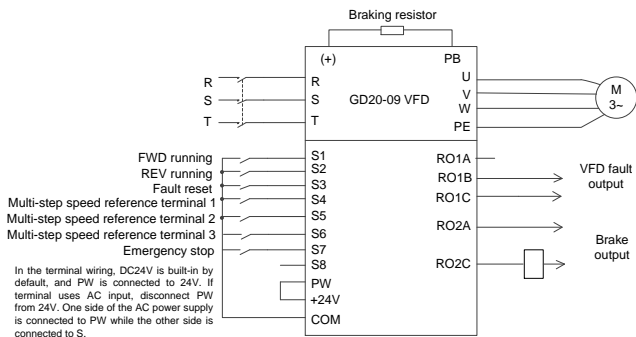

Figure 4-7 Wiring for multi-step speed reference

4.8.2 Commissioning procedure

1. Check the wiring and ensure the wiring is proper.
2. Set P00.18=1 (Restoring to the default values indicates that P19.00=1, namely open-loop vector controlled lifting application macro).
3. Set motor parameters in P02 group.
4. Set the function macro to be applied, and perform the wiring according to the wiring diagram, and set parameters of the multi-step speed reference application.
5. Perform low-speed trial running.

4.8.3 Application parameters

Function code	Name	Setting	Remarks
P00.01	Channel of running commands	1	1: Terminals
P00.06	Frequency A command	6	6: Multi-step speed reference
P05.03	Function of terminal S3	7	7: Fault reset
P05.04	Function of terminal S4	16	16: Multi-step speed reference terminal 1
P05.05	Function of terminal S5	17	17: Multi-step speed reference terminal 2

Function code	Name	Setting	Remarks
P05.06	Function of terminal S6	18	18: Multi-step speed reference terminal 3
P10.02	Multi-step speed 0	10.0%	Relative to the max. output frequency (P00.03)
P10.04	Multi-step speed 1	20.0%	Relative to the max. output frequency (P00.03)
P10.06	Multi-step speed 2	30.0%	Relative to the max. output frequency (P00.03)
P10.08	Multi-step speed 3	40.0%	Relative to the max. output frequency (P00.03)
P10.10	Multi-step speed 4	50.0%	Relative to the max. output frequency (P00.03)

4.8.4 Points for attention

1. If you only want to check whether the VFD runs properly, set P19.00=0 (Common mode).
2. If you perform empty-load commissioning, it is necessary to set the parameters according to the commissioning steps. If P19.13 and P19.16 (P19.27 and P19.28) are set to non-zero values, you need to set P19.13 and P19.16 (P19.27 and P19.28) to 0 to prevent the torque verification fault reporting caused by empty load. In addition, if no external braking resistor is connected, you need to increase the ACC/DEC time to prevent the bus overvoltage fault reporting caused by too fast stop.
3. During onsite commissioning, if the VFD terminal signal upward/downward running command is inconsistent with the load lifting/lowering direction, adjust any two phase sequences of VFD output terminals U, V, and W but not change the value of P00.13.
4. The application parameters can meet the requirements of most graded reference operating lever application cases, and do not need to be adjusted in most cases. If an exception occurs, see the function parameter chapter for adjustment or contact the technical support.

4.9 Commissioning motor-actuated potentiometer

4.9.1 Wiring

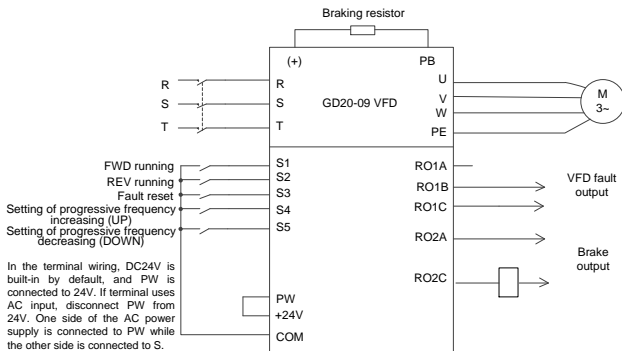

Figure 4-8 Wiring for motor-actuated potentiometer

Note: Perform the wiring according to Figure 4-8. If the onsite function terminals are inconsistent with the terminals shown in the figure, manually adjust the input and output terminal functions according to the actual wiring.

4.9.2 Commissioning procedure

1. Check the wiring and ensure the wiring is proper.
2. Set P00.18=1 (Restoring to the default values indicates that P19.00=1, namely open-loop vector controlled lifting application macro).
3. Set motor parameters in P02 group.
4. Set the function macro to be applied, and perform the wiring according to the wiring diagram, and set parameters of the motor-actuated potentiometer application.
5. Perform low-speed trial running.

4.9.3 Application parameters

Function code	Name	Setting	Remarks
P00.01	Channel of running commands	1	1: Terminals
P05.03	Function of terminal S3	7	7: Fault reset

Function code	Name	Setting	Remarks
P05.04	Function of terminal S4	10	10: Setting of progressive frequency increasing (UP)
P05.05	Function of terminal S5	11	11: Setting of progressive frequency decreasing (DOWN)
P08.44	UP/DOWN terminal control setting	0x010	<p>0x000–0x221</p> <p>LED ones place: Frequency control setting</p> <p>0: Setting through the UP/DOWN terminal is enabled.</p> <p>1: Setting through the UP/DOWN terminal is disabled.</p> <p>LED tens place: Frequency control setting</p> <p>0: Valid only when P00.06 is set to 0 or P00.07 is set to 0.</p> <p>1: All frequency modes are valid.</p> <p>2: Invalid for multi-step speed when multi-step speed takes precedence.</p> <p>LED hundreds place: Operation performed during stop</p> <p>0: The settings are enabled.</p> <p>1: The settings are enabled in running and deleted after the stop.</p> <p>2: The settings are enabled in running and deleted after a stop command is received.</p>

Note: If S terminal uses the AC power supply, it is necessary to perform wiring according to the AC wiring mode. After setting up the application parameters, it is necessary to set P27.13=1. Some parameters are factory default parameters, which are not be listed in the parameter table.

4.9.4 Points for attention

1. If you only want to check whether the VFD runs properly, set P19.00=0(Common mode).
2. If you perform empty-load commissioning, it is necessary to set the parameters according to the commissioning steps. If P19.13 and P19.16 (P19.27 and P19.28) are set to non-zero values, you need to set P19.13 and P19.16 (P19.27 and P19.28) to 0 to prevent the torque verification fault reporting caused by empty load. In addition, if no external braking resistor is connected, you need to increase the ACC/DEC time to prevent the bus overvoltage fault reporting caused by too fast stop.
3. During onsite commissioning, if the VFD terminal signal upward/downward running

command is inconsistent with the load lifting/lowering direction, adjust any two phase sequences of VFD output terminals U, V, and W but not change the value of P00.13.

4. The application parameters can meet the requirements of most motor-actuated potentiometer application cases, and do not need to be adjusted in most cases. If an exception occurs, see the function parameter chapter for adjustment or contact the technical support.

5 Keypad operation

5.1 Keypad introduction

The keypad is used to control the Goodrive20-09 VFDs for hoisting, read the state data, and modify parameters. If it is necessary to connect the keypad to other external device, you can use the standard RJ45 cable with crystal head as the external extension cable.

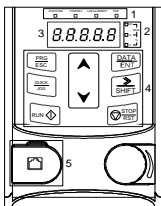

Figure 5-1 Film-type keypad

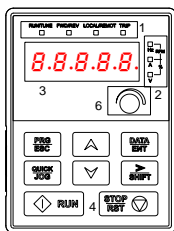
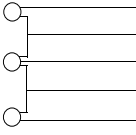









Figure 5-2 Keypad that can be used externally

Note:

The film-type keypad is a standard configuration for GD20-09 series VFDs. In addition, if you need, an external keypad (an optional part) can be provided (including the external keypads with and without the function of parameter copying).

SN	Name	Description
1	State indicator	<div style="border: 1px solid black; display: inline-block; padding: 2px;">RUN/TUNE</div> VFD running status indicator. LED off: The VFD is stopped. LED blinking: The VFD is autotuning parameters. LED on: The VFD is running.

SN	Name	Description							
		FWD/REV	Forward or reverse running indicator. LED off: The VFD is running forward. LED on: The VFD is running reversely.						
		LOCAL/REMOT	Indicates whether the VFD is controlled through the keypad, terminals, or remote communication. LED off: The VFD is controlled through the keypad. LED blinking: The VFD is controlled through terminals. LED on: The VFD is controlled through remote communication.						
		TRIP	Fault indicator. LED on: in fault state LED off: in normal state LED blinking: in pre-alarm state						
2	Unit indicator	Unit displayed currently							
			Hz	Frequency unit					
			RPM	Rotating speed unit					
			A	Current unit					
			%	Percentage					
		V	Voltage unit						
3	Digital display	Five-digit LED displays various monitoring data and alarm codes such as the set frequency and output frequency.							
		Display	Means	Display	Means	Display	Means	Display	Means
		0	0	1	1	2	2	3	3
		4	4	5	5	6	6	7	7
		8	8	9	9	A.	A	b.	B
		C.	C	d.	D	E.	E	F.	F
		H.	H	i.	I	L.	L	n.	N
		n	n	0	o	P.	P	r	r
		5.	S	t	t	U.	U	u	v
		.	.	-	-				
4	Buttons		Programming key	Press it to enter or exit level-1 menus or delete a parameter.					

SN	Name	Description	
			Enter key Press it to enter menus in cascading mode or confirm the setting of a parameter.
			Up key Press it to increase data or the function code progressively.
			Down key Press it to decrease data or the function code progressively.
			Right-shifting key Press it to select display parameters rightward in the interface for the device in stopped or running state or to select digits to change during parameter setting.
			Run key Press it to run the device when using the keypad for control.
			Stop/Reset key Press it to stop the device that is running. The function of this key is restricted by P07.04. In fault alarm state, this key can be used for reset in any control modes.
			Multifunctional shortcut key The function is determined by P07.02.
5	Keypad interface	External keypad interface. When the external keypad with the function of parameter copying is enabled, the local keypad is off; when the external keypad without the function of parameter copying is enabled, the local and external keypads are on at the same time. Note: Only the external keypad with the function of parameter copying is configured with the function of parameter copying.	
6	External keypad potentiometer	Namely, AI1. The external keypad AI1 is used as frequency reference source.	

5.2 Keypad display

The keypad of the Goodrive20-09 series VFD displays parameters in the stop state, parameters in the running state, function code parameter editing states, and fault alarm states.

5.2.1 Parameters displayed in the stop state

When the VFD is in the stop state, the keypad displays parameters.

Multiple state parameters can be displayed in the stop state. You can set a parameter to be displayed by setting the binary bits of P07.07. For definitions of the bits, see the description of P07.07.

7 parameters that can be selected to be displayed in the stop state include the set frequency, bus voltage, input terminal state, output terminal state, set torque, AI1, and AI2. Whether a parameter is to be displayed is set through the bits (transformed into binary bits) of P07.07. Press **▶/SHIFT** key to shift the display of the selected parameters from left to right, and press **QUICK/JOG** key (P07.02=2) to shift from right to left.

5.2.2 Parameters displayed in the running state

After receiving a valid running command, the VFD enters the running state, and parameters are displayed on the keypad. The **RUN/TUNE** indicator is on, and the on/off state of the **FWD/REV** indicator is determined by the running direction of the VFD.

18 parameters that can be selected to be displayed in the running state include the running frequency, set frequency, bus voltage, output voltage, output current, rotating speed in running, output power, output torque, input terminal state, output terminal state, set torque, AI1, AI2, motor overload percentage, VFD overload percentage, ramp frequency reference, linear speed, and AC input current. Whether a parameter is to be displayed is set through the bits (transformed into binary bits) of P07.05 and P07.06. Press **▶/SHIFT** key to shift the display of the selected parameters from left to right, and press **QUICK/JOG** key (P07.02=2) to shift from right to left.

5.2.3 Information displayed in the faulty state

After detecting a fault signal, the VFD enters the fault alarm state immediately, and the fault code blinks on the keypad. The **TRIP** indicator is on, and you can perform fault reset by using the **STOP/RST** key, control terminals, or communication commands.

If the fault still persists, the fault code is continuously displayed.

5.2.4 Function code editing state

You can press the **PRG/ESC** key to enter the editing state in the stop, running, or fault alarm state (if a user password is used, see the description of P07.00). Editing states are displayed through two levels of menus in the following sequence: function code group or function code number → function code parameter. Press the **DATA/ENT** key to enter the function parameter display interface. On the function parameter display interface, press the **DATA/ENT** key to save the parameter settings, and the **PRG/ESC** key to exit from the parameter display interface.



Figure 5-3 Keypad display

5.3 Operations on keypad

You can perform various operations on the rectifier by using a keypad. For details about the structure of the function codes, see the function code list.

5.3.1 Modifying function codes

The VFD provides three levels of menus, including:

1. Group number of function code (first-level menu)
2. Tab of function code (second-level menu)
3. Set value of function code (third-level menu)

Remarks: Pressing both the **PRG/ESC** and the **DATA/ENT** can return to the second-level menu from the third-level menu. The difference is: pressing **DATA/ENT** will save the set parameters into the control panel, and then return to the second-level menu with shifting to the next function code automatically; while pressing **PRG/ESC** will directly return to the second-level menu without saving the parameters, and keep staying at the current function code.

Under the third-level menu, if the parameter has no flickering bit, it means the function code cannot be modified. The possible reasons could be:

- 1) This function code is not modifiable parameter, such as actual detected parameter, operation records and so on;
- 2) This function code is not modifiable in running state, but modifiable in stop state.

Example: Set function code P00.01 from 0 to 1.

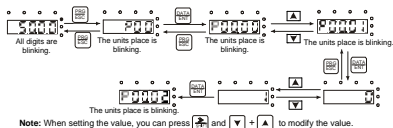

Figure 5-4 Sketch map of modifying parameters

5.3.2 Setting the password of the VFD

Goodrive20-09 series VFDs for hoisting provide user password protection function. When P07.00 is set to a non-zero value, the value is the user password. The password protection becomes valid instantly after quitting from the function code editing state. Press **PRG/ESC** again to enter the function code editing state, "0.0.0.0.0" will be displayed. Unless using the correct password, you cannot enter it.

Set P07.00 to 0 to cancel password protection function.

The password protection takes effect one minute after retreating from the function code editing state. After the password protection function takes effect, press **PRG/ESC** again to enter the function code editing state, "0.0.0.0.0" will be displayed. Unless using the correct password, you cannot enter it.

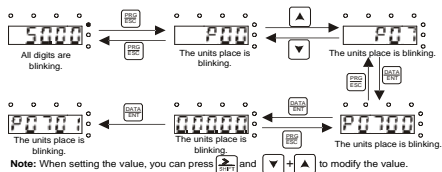

Figure 5-5 Sketch map of password setting

5.3.3 Viewing the VFD state through function codes

Goodrive20-09 series VFDs provide group P17 as the state viewing group. You can enter P17 directly to view the state.

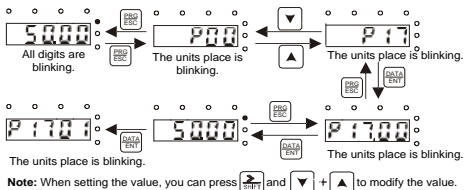

Figure 5-6 Sketch map of state viewing

6 Function parameter list

The function parameters of GD20-09 series VFDs are divided by function into 30 groups, P00 to P29. Each function group includes several function codes. Three levels of menus are applied for function codes. For example, "P08.08" indicates the 8th function code in the P08 group. The P29 group indicates factory function parameters, and you have no access to it.

To facilitate the settings of function codes, the function group numbers correspond to the Level-1 menus, the function codes correspond to the Level-2 menus, and the function code parameters correspond to the Level-3 menus.

1. The content of the function table is as follows:

Column 1 "Function code ": Code of the function group and parameter

Column 2 "Name": Full name of the function parameter

Column 3 "Detailed description": Detailed description of the function parameter

Column 4 "Default value": Initial value of the function parameter set in factory

Column 5 "Modify": Whether the function parameter can be modified, and conditions for the modification

"○" indicates that the value of the parameter can be modified when the VFD is in stopped or running state.

"◎" indicates that the value of the parameter cannot be modified when the VFD is in running state.

"●" indicates that the value of the parameter is detected and recorded, and cannot be modified.

(The VFD automatically checks and constrains the modification of parameters, which helps prevent incorrect modifications.)

2. The parameters adopt the decimal system (DEC). If the hexadecimal system is adopted, all bits are mutually independent on data during parameter editing, and the setting ranges at some bits can be hexadecimal (0–F).

3. "Default value" indicates the factory setting of the function parameter. If the value of the parameter is detected or recorded, the value cannot be restored to the factory setting.

4. To better protect parameters, the VFD provides the password protection function. After a password is set (that is, P07.00 is set to a non-zero value), "0.0.0.0.0" is displayed when you press the **PRG/ESC** key to enter the function code editing interface. You need to enter the correct user password to enter the interface. For the factory parameters, you need to enter the correct factory password to enter the interface. (You are not advised to modify the factory

parameters. Incorrect parameter setting may cause operation exceptions or even damage to the VFD.) When password protection does not take effect, you can change the password any time. When P07.00 is set to 0, no user password is used. When P07.00 is set to a non-zero value during VFD power-on, parameters are prevented from being modified by using the user password function.

5. When you modify function parameters through serial communication, the user password protection function is also applicant and compliant with the same rule.

Note:

The VFD automatically checks and constrains the modification of parameters, which helps prevent incorrect modifications.

P00 group Basic functions

Function code	Name	Detailed description	Default value	Modify
P00.00	Speed control mode	1: SVC 1 2: SVPWM Note: If the vector mode is used, it is required to carry out the motor parameter autotuning first.	1	☉
P00.01	Channel of running commands	0: Keypad (LED is off) 1: Terminals (LED blinks) 2: Communication (LED is on)	0	○
P00.02	Communication channel of running commands	0: Modbus 1–3: Reserved	0	○
P00.03	Max. output frequency	10.00–150.00Hz	50.00Hz	☉
P00.04	Upper limit of running frequency	P00.05–P00.03 (max. output frequency)	50.00Hz	☉
P00.05	Lower limit of running frequency	0.00Hz–P00.04 (upper limit of running frequency)	0.00Hz	☉
P00.06	Frequency A command	0: Keypad 1: AI1 (external keypad potentiometer) 2: AI2 3–5: Reserved 6: Multi-step speed running 7: Reserved 8: Modbus communication 9–12: Reserved	0	○

Function code	Name	Detailed description	Default value	Modify										
		13: Graded multi-step speed reference												
P00.07	Frequency B command	0: Keypad 1: AI1 (external keypad potentiometer) 2: AI2 3-5: Reserved 6: Multi-step speed running 7: Reserved 8: Modbus communication 9-12: Reserved 13: Graded multi-step speed reference	2	<input type="radio"/>										
P00.08	Frequency B setting reference	0: Max. output frequency 1: Frequency A command	0	<input type="radio"/>										
P00.09	Setting source combination mode	0: A 1: B 2: (A+B) 3: (A-B) 4: Max. (A, B) 5: Min. (A, B)	0	<input type="radio"/>										
P00.10	Frequency set through keypad	0.00 Hz-P00.03 (max. output frequency)	50.00Hz	<input type="radio"/>										
P00.11	ACC time 1	0.0-3600.0 s	Depend on model	<input type="radio"/>										
P00.12	DEC time 1	0.0-3600.0 s	Depend on model	<input type="radio"/>										
P00.13	Running direction	0: Run in default direction 1: Run in reverse direction 2: Reverse running is prohibited	0	<input type="radio"/>										
P00.14	Carrier frequency	<table border="1"> <thead> <tr> <th>Carrier frequency</th> <th>Electro magnetic noise</th> <th>Noise and leakage current</th> <th>Cooling level</th> </tr> </thead> <tbody> <tr> <td>1kHz</td> <td rowspan="3">↑ High ↓ Low</td> <td rowspan="3">↑ Low ↓ High</td> <td rowspan="3">↑ Low ↓ High</td> </tr> <tr> <td>10kHz</td> </tr> <tr> <td>15kHz</td> </tr> </tbody> </table> <p>The relation between the model and carrier frequency is shown below.</p>	Carrier frequency	Electro magnetic noise	Noise and leakage current	Cooling level	1kHz	↑ High ↓ Low	↑ Low ↓ High	↑ Low ↓ High	10kHz	15kHz	Depend on model	<input type="radio"/>
Carrier frequency	Electro magnetic noise	Noise and leakage current	Cooling level											
1kHz	↑ High ↓ Low	↑ Low ↓ High	↑ Low ↓ High											
10kHz														
15kHz														

Function code	Name	Detailed description	Default value	Modify						
		<table border="1"> <thead> <tr> <th>VFD model</th> <th>Default value of carrier frequency</th> </tr> </thead> <tbody> <tr> <td>0.75kW–11kW</td> <td>4kHz</td> </tr> <tr> <td>Above 15kW</td> <td>1.5kHz</td> </tr> </tbody> </table> <p>Advantages of high carrier frequency are as follows: ideal current waveform, few current harmonics and small motor noise.</p> <p>Disadvantages of high carrier frequency are as follows: growing switch consumption, enlarged temperature rise, impacted output capacity; under high carrier frequency, the VFD needs to be derated for use, meanwhile, the leakage current will increase, which increases electromagnetic interference to the surroundings.</p> <p>While low carrier frequency is the contrary. Low carrier frequency will cause unstable operation at low frequency, decrease the torque, or even lead to oscillation.</p> <p>The carrier frequency of VFD is set properly by default, and it should not be changed at will.</p> <p>If the default carrier frequency is exceeded during use, derating is required, derate by 10% for every additional 1k carrier frequency.</p> <p>Setting range: 1.0–15.0kHz</p>	VFD model	Default value of carrier frequency	0.75kW–11kW	4kHz	Above 15kW	1.5kHz		
VFD model	Default value of carrier frequency									
0.75kW–11kW	4kHz									
Above 15kW	1.5kHz									
P00.15	Motor parameter autotuning	0: No operation 1: Rotary autotuning 2: Static autotuning 1 (autotuning all parameters) 3: Static autotuning 2 (autotuning some parameters)	0	⊙						
P00.16	AVR function setting	0: Disabled	1	○						

Function code	Name	Detailed description	Default value	Modify
		1: Always enabled		
P00.18	Function parameter restoration	0: No operation 1: Restoring to the default values (Restoring to the default values indicates that P19.00=1, namely open-loop vector controlled lifting application macro) 2: Deleting fault files 3: Function code locking (lock all function codes)	0	⊙

P01 group Start and stop control

Function code	Name	Detailed description	Default value	Modify
P01.00	Start mode	0: Direct start 1: Start after DC braking	0	⊙
P01.01	Start frequency at direct start	0.00–50.00 Hz	0.50 Hz	⊙
P01.02	Start frequency holding time	0.0–50.0 s	0.0 s	⊙
P01.03	Braking current before start	0.0–100.0% (of the rated current of the VFD)	0.0%	⊙
P01.04	Braking time before start	0.00–50.00 s	0.00 s	⊙
P01.05	ACC/DEC mode	0: Straight line; the output frequency increases or decreases in straight line; 1: S curve type 1 (ACC discontinuous type); The output frequency increases or decreases in S curve; 2: S curve type 2 (ACC continuous type); S curve is generally used in cases where smooth start/stop is required, eg, elevator, conveyer belt, etc.	0	⊙
P01.06	ACC time in the S-curve start section	0.0–50.0s	0.1 s	○
P01.07	DEC time in the S-curve end section	0.0–50.0s	0.1 s	○
P01.08	Stop mode	0: Decelerate to stop	0	○

Function code	Name	Detailed description	Default value	Modify
		1: Coast to stop		
P01.09	Start frequency at stop braking	0.00–P00.03 (max. output frequency)	0.00 Hz	<input type="radio"/>
P01.10	Waiting time before stop braking	0.00–50.00 s	0.00 s	<input type="radio"/>
P01.11	DC braking current at stop	0.0–100.0% (of the rated current of the VFD)	0.0%	<input type="radio"/>
P01.12	DC braking time at stop	0.00–50.00 s	0.00 s	<input type="radio"/>
P01.13	FWD/REV dead time	0.0–3600.0 s	0.0 s	<input type="radio"/>
P01.14	FWD/REV switching mode	0: Switching at zero frequency 1: Switching when the start frequency is reached. 2: Switch over after passing the stop speed and delay	1	<input checked="" type="radio"/>
P01.15	Stop speed	0.00–100.00 Hz	0.50 Hz	<input checked="" type="radio"/>
P01.16	Stop speed detection mode	0: Detecting based on the speed setting (no stop delay) 1: Detecting based on speed feedback (valid only for vector control)	1	<input checked="" type="radio"/>
P01.17	Speed feedback detection time	0.00–100.00 s (valid only when P01.16 = 1)	0.50 s	<input checked="" type="radio"/>
P01.18	Terminal-based running command protection at power-on	0: Terminal-based running commands are disabled. 1: Terminal-based running commands are enabled.	0	<input type="radio"/>
P01.19	Action performed when the running frequency is lower than the lower frequency limit (valid when the lower frequency limit is greater than 0)	0: Run at the lower frequency limit 1: Stop 2: Hibernation and standby	0	<input checked="" type="radio"/>
P01.20	Time for recovery from hibernation	0.0–3600.0 s (valid when P01.15 is 2)	0.0 s	<input type="radio"/>
P01.21	Restart after power	0: Disable restart	0	<input type="radio"/>

Function code	Name	Detailed description	Default value	Modify
	outage	1: Enable restart		
P01.22	Waiting time for restart after power outage	0.0–3600.0 s (valid when P01.21 is 1)	1.0 s	<input type="radio"/>
P01.23	Start delay	0.0–60.0 s	0.0 s	<input type="radio"/>
P01.24	Stop speed delay	0.0–100.0 s	0.0 s	<input type="radio"/>
P01.25	0 Hz output	0: No voltage output 1: With voltage output 2: Output as per DC braking current during stop	0	<input type="radio"/>

P02 group Motor 1 parameters

Function code	Name	Detailed description	Default value	Modify
P02.01	Rated power of AM 1	0.1–3000.0kW	Depend on model	<input checked="" type="radio"/>
P02.02	Rated frequency of AM 1	0.01 Hz–P00.03 (max. output frequency)	50.00Hz	<input checked="" type="radio"/>
P02.03	Rated rotating speed of AM 1	1–36000rpm	Depend on model	<input checked="" type="radio"/>
P02.04	Rated voltage of AM 1	0–1200V	Depend on model	<input checked="" type="radio"/>
P02.05	Rated current of AM 1	0.8–6000.0A	Depend on model	<input checked="" type="radio"/>
P02.06	Stator resistance of AM 1	0.001–65.535Ω	Depend on model	<input type="radio"/>
P02.07	Rotor resistance of AM 1	0.001–65.535Ω	Depend on model	<input type="radio"/>
P02.08	Leakage inductance of AM 1	0.1–6553.5 mH	Depend on model	<input type="radio"/>
P02.09	Mutual inductance of	0.1–6553.5 mH	Depend	<input type="radio"/>

Function code	Name	Detailed description	Default value	Modify
	AM 1		on model	
P02.10	Empty-load current of AM 1	0.1–6553.5 A	Depend on model	<input type="radio"/>
P02.11	Magnetic saturation factor 1 of iron core of AM 1	0.0–100.0%	80.0%	<input type="radio"/>
P02.12	Magnetic saturation factor 2 of iron core of AM 1	0.0–100.0%	68.0%	<input type="radio"/>
P02.13	Magnetic saturation factor 3 of iron core of AM 1	0.0–100.0%	57.0%	<input type="radio"/>
P02.14	Magnetic saturation factor 4 of iron core of AM 1	0.0–100.0%	40.0%	<input type="radio"/>
P02.26	Overload protection on motor 1	0: No protection 1: Common motor (equipped with low-speed compensation) 2: Variable-frequency motor (without low-speed compensation)	2	<input checked="" type="radio"/>
P02.27	Overload protection coefficient for motor 1	20.0%–120.0%	100.0%	<input type="radio"/>

P03 group Vector control

Function code	Name	Detailed description	Default value	Modify
P03.00	ASR proportional gain 1	0–200.0	20.0	<input type="radio"/>
P03.01	ASR integral time 1	0.000–10.000 s	0.200 s	<input type="radio"/>
P03.02	Low-point frequency for switching	0.00 Hz–P03.05	5.00 Hz	<input type="radio"/>
P03.03	ASR proportional gain 2	0–200.0	20.0	<input type="radio"/>
P03.04	ASR integral time 2	0.000–10.000 s	0.200 s	<input type="radio"/>
P03.05	High-point frequency	P03.02–P00.03 (max. output frequency)	10.00	<input type="radio"/>

Function code	Name	Detailed description	Default value	Modify
	for switching		Hz	
P03.06	ASR output filter	0–8 (corresponding to 0–2 ⁸ /10ms)	0	<input type="radio"/>
P03.07	Vector control slip compensation coefficient (electromotion)	50%–200%	100%	<input type="radio"/>
P03.08	Vector control slip compensation coefficient (power generation)	50%–200%	100%	<input type="radio"/>
P03.09	ACR proportional coefficient P	0–65535	1000	<input type="radio"/>
P03.10	ACR integral coefficient I	0–65535	1000	<input type="radio"/>
P03.11	Torque setting mode	0: Torque control disabled 1: Keypad (P03.12) 2: Analog input AI1 (100% corresponds to three times of the rated current of the motor) 3: Analog input AI2 (the same as above) 4–5: Reserved 6: Multi-step torque setting (the same as above) 7: Modbus communication (the same as above) 8–10: Reserved	0	<input type="radio"/>
P03.12	Torque set through keypad	-300.0%–+300.0% (of the rated current of the motor)	50.0%	<input type="radio"/>
P03.13	Torque setting filtering time	0.000–10.000 s	0.100 s	<input type="radio"/>
P03.14	Forward running frequency upper limit setting mode in torque control	0: Keypad (P03.16) 1: Analog input AI1 (100% corresponds to the max. frequency) 2: Analog input AI2 (the same as above) 3–4: Reserved 5: Multi-step setting (the same as above) 6: Modbus communication (the same as	0	<input type="radio"/>

Function code	Name	Detailed description	Default value	Modify
		above) 7-9: Reserved		
P03.15	Reverse running frequency upper limit setting mode in torque control	0: Keypad (P03.17) 1: Analog input AI1 (100% corresponds to the max. frequency) 2: Analog input AI2 (the same as above) 3-4: Reserved 5: Multi-step setting (the same as above) 6: Modbus communication (the same as above) 7-9: Reserved	0	<input type="radio"/>
P03.16	Forward running frequency upper limit set through keypad in torque control	0.00 Hz-P00.03	50.00 Hz	<input type="radio"/>
P03.17	Reverse running frequency upper limit set through keypad in torque control	0.00 Hz-P00.03	50.00Hz	<input type="radio"/>
P03.18	Electromotive torque upper limit setting mode	0: Keypad (P03.20) 1: Analog input AI1 (100% corresponds to three times of the rated current of the motor) 2: Analog input AI2 (the same as above) 3-4: Reserved 5: Modbus communication (the same as above) 6-8: Reserved	0	<input type="radio"/>
P03.19	Brake torque upper limit setting mode	0: Keypad (P03.21) 1: Analog input AI1 (100% corresponds to three times of the rated current of the motor) 2: Analog input AI2 (the same as above) 3-4: Reserved 5: Modbus communication (the same as above) 6-8: Reserved	0	<input type="radio"/>

Function code	Name	Detailed description	Default value	Modify
P03.20	Electromotive torque upper limit set through keypad	0.0–300.0% (of the rated current of the motor)	180.0%	<input type="radio"/>
P03.21	Brake torque upper limit set through keypad	0.0–300.0% (of the rated current of the motor)	180.0%	<input type="radio"/>
P03.22	Flux-weakening coefficient in the constant power zone	0.1–2.0	0.3	<input type="radio"/>
P03.23	Lowest flux-weakening point in the constant power zone	10%–100%	20%	<input type="radio"/>
P03.24	Upper limit of voltage	0.0–120.0%	100.0%	<input checked="" type="radio"/>
P03.25	Pre-exciting time	0.000–10.000s	0.300s	<input type="radio"/>
P03.26	Flux-weakening proportional gain	0–8000	1200	<input type="radio"/>
P03.27	Vector control speed display	0: Display as per actual value 1: Display as per the set value	0	<input type="radio"/>
P03.28	Static friction compensation coefficient	0–100.0%	0	<input type="radio"/>
P03.29	Dynamical friction compensation coefficient	0–100.0%	0	<input type="radio"/>

P04 group V/F control

Function code	Name	Detailed description	Default value	Modify
P04.00	V/F curve of motor 1	0: Linear V/F curve 1: Multi-point V/F curve 2: Torque-stepdown characteristic V/F curve (1.3 order) 3: Torque-stepdown characteristic V/F curve (1.7 order) 4: Torque-stepdown characteristic V/F curve (2.0 order) 5: User-defined V/F curve (V/F	0	<input checked="" type="radio"/>

Function code	Name	Detailed description	Default value	Modify
		separation)		
P04.01	Torque boost of motor 1	0.0%: (automatic) 0.1%–10.0%	0.0%	<input type="radio"/>
P04.02	Torque boost stop threshold for motor 1	0.0%–50.0% (of the rated frequency of motor 1)	20.0%	<input type="radio"/>
P04.03	V/F frequency point 1 of motor 1	0.00Hz–P04.05	0.00Hz	<input type="radio"/>
P04.04	V/F voltage point 1 of motor 1	0.0%–110.0% (of the rated voltage of motor 1)	00.0%	<input type="radio"/>
P04.05	V/F frequency point 2 of motor 1	P04.03–P04.07	00.00Hz	<input type="radio"/>
P04.06	V/F voltage point 2 of motor 1	0.0%–110.0% (of the rated voltage of motor 1)	00.0%	<input type="radio"/>
P04.07	V/F frequency point 3 of motor 1	P04.05–P02.02 (of the rated frequency of motor 1)	00.00Hz	<input type="radio"/>
P04.08	V/F voltage point 3 of motor 1	0.0%–110.0% (of the rated voltage of motor 1)	00.0%	<input type="radio"/>
P04.09	V/F slip compensation gain of motor 1	0.0–200.0%	100.0%	<input type="radio"/>
P04.10	Low-frequency oscillation control factor of motor 1	0–100	10	<input type="radio"/>
P04.11	High-frequency oscillation control factor of motor 1	0–100	10	<input type="radio"/>
P04.12	Oscillation control threshold for motor 1	0.00 Hz–P00.03 (max. output frequency)	30.00 Hz	<input type="radio"/>
P04.26	Energy-saving running setting	0: No action 1: Automatic energy-saving running	0	<input checked="" type="radio"/>
P04.27	Channel of voltage setup	0: Keypad (determined by P04.28) 1: AI1 2: AI2 3–4: Reserved 5: Multi-step (the set value is determined by P10 group) 6: Reserved	0	<input type="radio"/>

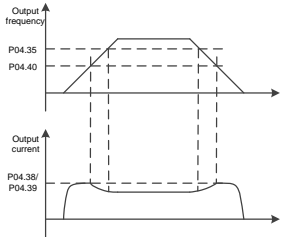
Function code	Name	Detailed description	Default value	Modify
		7: Modbus communication 8–10: Reserved		
P04.28	Voltage value set through keypad	0.0%–100.0%	100.0%	<input type="radio"/>
P04.29	Voltage increasing time	0.0–3600.0 s	5.0 s	<input type="radio"/>
P04.30	Voltage decreasing time	0.0–3600.0 s	5.0 s	<input type="radio"/>
P04.31	Max. output voltage	P04.32–100.0% (of the rated voltage of the motor)	100.0%	<input checked="" type="radio"/>
P04.32	Min. output voltage	0.0%–P04.31 (of the rated voltage of the motor)	0.0%	<input checked="" type="radio"/>
P04.33	Flux-weakening coefficient in the constant power zone	1.00–1.30	1.00	<input type="radio"/>
P04.35	Frequency threshold for completely switching off I/F control	P04.40–50.00Hz When the ramp frequency exceeds this frequency threshold, I/F current closed-loop control is switched off, and the output voltage of the regulator is decreased gradually. When the frequency set in P04.35 is reached, the voltage of the regulator is decreased to 0.	25.00 Hz	<input type="radio"/>
P04.36	Current proportional coefficient P for I/F control	0–5000 I/F control is disabled when this parameter is 0. 	0	<input type="radio"/>

Function code	Name	Detailed description	Default value	Modify
		Note: The I/F mode is not applicable to conical motor applications.		
P04.37	Current integral coefficient I for I/F control	0–5000	150	<input type="radio"/>
P04.38	Current setting for forward I/F control	0.0%–200.0%	140%	<input type="radio"/>
P04.39	Current setting for reverse I/F control	0.0%–200.0%	100%	<input type="radio"/>
P04.40	Frequency threshold for switching off I/F control	0.00Hz–25.00 Hz When the ramp frequency exceeds this frequency threshold, I/F current closed-loop control is switched off, and the output voltage of the regulator is decreased gradually. When the frequency set in P04.35 is reached, the voltage of the regulator is decreased to 0.	10.00 Hz	<input type="radio"/>

P05 group Input terminals

Function code	Name	Detailed description	Default value	Modify
P05.01	Function of terminal S1	0: No function 1: Forward running	1	<input checked="" type="radio"/>
P05.02	Function of terminal S2	2: Reverse running 3: 3-wire running control	2	<input checked="" type="radio"/>
P05.03	Function of terminal S3	4: Forward jogging 5: Reverse jogging	61	<input checked="" type="radio"/>
P05.04	Function of terminal S4	6: Coasting to stop 7: Fault reset	7	<input checked="" type="radio"/>
P05.05	Function of terminal S5	8: Suspend running 9: External fault input	68	<input checked="" type="radio"/>
P05.06	Function of terminal S6	10: Setting of progressive frequency increasing (UP)	69	<input checked="" type="radio"/>
P05.07	Function of terminal S7	11: Setting of progressive frequency decreasing (DOWN)	66	<input checked="" type="radio"/>
P05.08	Function of terminal S8	12: Cancel the setting of frequency increasing/decreasing	67	<input checked="" type="radio"/>

Function code	Name	Detailed description	Default value	Modify
		13: Switching between setting A and setting B 14: Switching between combined setting and setting A 15: Switching between combined setting and setting B 16: Multi-step speed terminal 1 17: Multi-step speed terminal 2 18: Multi-step speed terminal 3 19: Multi-step speed terminal 4 20: Multi-step speed suspended 21: ACC/DEC time selection 1 22: ACC/DEC time selection 2 23–28: Reserved 29: Disable torque control 30: Disable ACC/DEC 31–32: Reserved 33: Temporarily delete the setting of frequency increasing/decreasing 34: DC braking at stop 35: Reserved 36: Switch to the command channel of keypad 37: Switch to the command channel of terminal 38: Switch to the command channel of communication 39: Pre-exciting command 40: Delete the power consumption records 41: Keep the power consumption records 42–57: Reserved 58: Quick stop 59: Brake feedback signal 60: Operating lever zero-point position signal 61: Graded reference terminal 1 62: Graded reference terminal 2		

Function code	Name	Detailed description	Default value	Modify
		63: Graded reference terminal 3 64: Graded reference terminal 4 65: Graded reference terminal 5 66: Upward position limit 67: Downward position limit 68: Upward DEC position limit 69: Downward DEC position limit 70: Light-load speed boost signal 71: PTC overtemperature valid signal 72: VFD enabling signal		
P05.10	Input terminal polarity	0x000–0x1FF	0x000	○
P05.11	Digital filtering time	0.000–1.000 s	0.010 s	○
P05.12	Virtual terminal setting	0x000–0x1FF (0: Disable; 1: Enable) Bit 0: Enable virtual terminal S1 Bit 1: Enable virtual terminal S2 Bit 2: Enable virtual terminal S3 Bit 3: Enable virtual terminal S4 Bit 4: Enable virtual terminal S5 Bit 5: Enable virtual terminal S6 Bit 6: Enable virtual terminal S7 Bit 7: Enable virtual terminal S8 Bit 8: Reserved Note: After the virtual terminal is enabled, the state of the terminal can only be modified through communication, and the communication address is 0x200A.	0x000	◎
P05.13	Terminal-based control mode	0: 2-wire control mode 1 1: 2-wire control mode 2 2: 3-wire control mode 1 3: 3-wire control mode 2	0	◎
P05.14	Switch-on delay of terminal S1	0.000–50.000 s	0.000 s	○
P05.15	Switch-off delay of terminal S1	0.000–50.000 s	0.000 s	○
P05.16	Switch-on delay of	0.000–50.000 s	0.000 s	○

Function code	Name	Detailed description	Default value	Modify
	terminal S2			
P05.17	Switch-off delay of terminal S2	0.000–50.000 s	0.000 s	<input type="radio"/>
P05.18	Switch-on delay of terminal S3	0.000–50.000 s	0.000 s	<input type="radio"/>
P05.19	Switch-off delay of terminal S3	0.000–50.000 s	0.000 s	<input type="radio"/>
P05.20	Switch-on delay of terminal S4	0.000–50.000 s	0.000 s	<input type="radio"/>
P05.21	Switch-off delay of terminal S4	0.000–50.000 s	0.000 s	<input type="radio"/>
P05.22	Switch-on delay of terminal S5	0.000–50.000 s	0.000 s	<input type="radio"/>
P05.23	Switch-off delay of terminal S5	0.000–50.000 s	0.000 s	<input type="radio"/>
P05.24	Switch-on delay of terminal S6	0.000–50.000 s	0.000 s	<input type="radio"/>
P05.25	Switch-off delay of terminal S6	0.000–50.000 s	0.000 s	<input type="radio"/>
P05.26	Switch-on delay of terminal S7	0.000–50.000 s	0.000 s	<input type="radio"/>
P05.27	Switch-off delay of terminal S7	0.000–50.000 s	0.000 s	<input type="radio"/>
P05.28	Switch-on delay of terminal S8	0.000–50.000 s	0.000 s	<input type="radio"/>
P05.29	Switch-off delay of terminal S8	0.000–50.000 s	0.000 s	<input type="radio"/>
P05.32	Lower limit of AI1	AI1 is set by the analog potentiometer, and AI2 is set by the control terminal AI2. Setting range of P05.32: 0.00 V–P05.34 Setting range of P05.33: -100.0%–100.0% Setting range of P05.34: P05.32–10.00 V Setting range of P05.35: -100.0%–100.0% Setting range of P05.36: 0.000 s–10.000 s	0.00 V	<input type="radio"/>
P05.33	Setting corresponding to lower limit of AI1		0.0%	<input type="radio"/>
P05.34	Upper limit of AI1		10.00 V	<input type="radio"/>
P05.35	Setting corresponding to upper limit of AI1		100.0%	<input type="radio"/>
P05.36	AI1 input filtering time		0.100 s	<input type="radio"/>

Function code	Name	Detailed description	Default value	Modify
P05.37	Lower limit of AI2	Setting range of P05.37: 0.00 V~P05.39	0.00 V	<input type="radio"/>
P05.38	Setting corresponding to lower limit of AI2	Setting range of P05.38: -100.0%~100.0%	0.0%	<input type="radio"/>
P05.39	Upper limit of AI2	Setting range of P05.39: P05.37~10.00 V	10.00 V	<input type="radio"/>
P05.40	Setting corresponding to upper limit of AI2	Setting range of P05.40: -100.0%~100.0%	100.0%	<input type="radio"/>
P05.41	AI2 input filtering time	Setting range of P05.41: 0.000 s~10.000 s	0.100 s	<input type="radio"/>

P06 group Output terminals

Function code	Name	Detailed description	Default value	Modify
P06.02	Relay RO3 output	0: Disabled	0	<input type="radio"/>
P06.03	Relay RO1 output	1: In running	1	<input type="radio"/>
P06.04	Relay RO2 output	2: Forward running 3: Reverse running 4: Jogging 5: VFD fault 6: Frequency level detection FDT1 7: Frequency level detection FDT2 8: Frequency reached 9: Running in zero speed 10: Upper frequency limit reached 11: Lower frequency limit reached 12: Ready to run 13: In pre-exciting 14: Overload pre-alarm 15: Underload pre-alarm 16~19: Reserved 20: External fault valid 21: Reserved 22: Running time reached 23: Modbus communication virtual terminal output 24~25: Reserved 26: DC bus voltage established	5	<input type="radio"/>

Function code	Name	Detailed description	Default value	Modify
		27-36: Reserved 37: Protection against overload 38: Brake control 39: Upward position limit reached 40: Downward position limit reached 41: Protection against low voltage 42: PT100 alarm 43: PTC alarm 44: Light-load speed boost 45: Input phase loss alarm 46: Derating frequency with voltage		
P06.05	Output terminal polarity	00-0F Bit0-Reserved Bit1- RO3 Bit2- RO1 Bit3- RO2	00	○
P06.08	Relay RO3 switch-on delay	0.000-50.000 s	0.000 s	○
P06.09	Relay RO3 switch-off delay	0.000-50.000 s	0.000 s	○
P06.10	Relay RO1 switch-on delay	0.000-50.000 s	0.000 s	○
P06.11	Relay RO1 switch-off delay	0.000-50.000 s	0.000 s	○
P06.12	Relay RO2 switch-on delay	0.000-50.000 s	0.000 s	○
P06.13	Relay RO2 switch-off delay	0.000-50.000 s	0.000 s	○

P07 group HMI

Function code	Name	Detailed description	Default value	Modify
P07.00	User password	0-65535	0	○
P07.01	Function parameter copy	0: No operation 1: Uploading function parameters from the machine to keypad 2: Downloading function parameters (including the motor parameters) from	0	◎

Function code	Name	Detailed description	Default value	Modify
		<p>the keypad to machine</p> <p>3: Downloading function parameters (excluding motor parameters of the P02 and P12 groups) from the keypad to machine</p> <p>4: Downloading function parameters (only motor parameters of the P02 and P12 groups) from the keypad to machine</p> <p>Note: After the parameter is set to 1, 2, 3 or 4, and the operation is executed, the parameter is automatically restored to 0. The parameters uploaded or downloaded do not include those of the P29 group (factory function parameters). The function is valid only for the optional external keypad with the function of parameter copying.</p>		
P07.02	Function of keys	<p>Ones place: Function selection of QUICK/JOG key</p> <p>0: No function</p> <p>1: Jogging</p> <p>2: Switch the display state by using the shifting key</p> <p>3: Switch between forward running and reverse running</p> <p>4: Delete the UP/DOWN setting</p> <p>5: Coast to stop</p> <p>6: Switch over the running command reference mode in sequence</p> <p>7: Quick commissioning mode (based on the non-factory parameter settings)</p> <p>Tens place:</p> <p>0: Keypad keys are not locked</p> <p>1: All keypad keys are locked</p> <p>2: Partial keypad keys are locked (only the PRG/ESC button is locked)</p>	0x01	◎
P07.03	Sequence of	0: Keypad control → terminal control →	0	○

Function code	Name	Detailed description	Default value	Modify
	switching the channels of running commands by using QUICK	communication control 1: Keypad control ← → terminal control 2: Keypad control ← → communication control 3: Terminal control ← → communication control		
P07.04	STOP/RST stop function	0: Valid only for panel control 1: Valid for both panel and terminal control 2: Valid for both panel and communication control 3: Valid for all control modes	0	○
P07.05	Selection 1 of parameters to be displayed in the running state	0x0000–0xFFFF Bit 0: Running frequency (Hz on) Bit 1: Set frequency (Hz blinking) Bit 2: Bus voltage (V on) Bit 3: Output voltage (V on) Bit 4: Output current (A on) Bit 5: Rotating speed in running (rpm on) Bit 6: Output power (% on) Bit 7: Output torque (% on) Bit 8–Bit 9: Reserved Bit 10: Input terminal state Bit 11: Output terminal state Bit 12: Set torque (% on) Bit 13–15: Reserved	0x03FF	○
P07.06	Selection 2 of parameters to be displayed in the running state	0x0000–0xFFFF Bit 0: AI1 (V on) Bit 1: AI2 (V on) Bit 2–Bit 3: Reserved Bit 4: Motor overload percentage (% on) Bit 5: VFD overload percentage (% on) Bit 6: Ramp frequency reference (Hz on) Bit 7: Linear speed Bit 8: AC incoming current Bit 9–15: Reserved	0x0000	
P07.07	Selection of parameters to be	0x0000–0xFFFF Bit 0: Set frequency (Hz on, blinking	0x00FF	○

Function code	Name	Detailed description	Default value	Modify
	displayed in the stop state	slowly) Bit 1: Bus voltage (V on) Bit 2: Input terminal state Bit 3: Output terminal state Bit 4: Reserved Bit 5: Reserved Bit 6: Set torque (% on) Bit 7: AI1 (V on) Bit 8: AI2 (V on) Bit 9–Bit 15: Reserved		
P07.08	Frequency display coefficient	0.01–10.00 Displayed frequency = Running frequency × P07.08	1.00	<input type="radio"/>
P07.09	Rotating speed display coefficient	0.1–999.9% Displayed mechanical rotating speed = 30 × Displayed running frequency × P07.09 / Number of pole pairs of the motor	100.0%	<input type="radio"/>
P07.10	Linear speed display coefficient	0.1–999.9% Displayed linear speed = Mechanical rotating speed × P07.10	1.0%	<input type="radio"/>
P07.11	Bridge rectifier module temperature	0–100.0℃		<input checked="" type="radio"/>
P07.12	Inverter module temperature	0–100.0℃		<input checked="" type="radio"/>
P07.13	Control board software version	1.00–655.35		<input checked="" type="radio"/>
P07.14	Accumulated running time	0–65535h		<input checked="" type="radio"/>
P07.15	MSB of power consumption	0–65535 kWh (×1000)		<input checked="" type="radio"/>
P07.16	LSB of power consumption	0.0–999.9 kWh		<input checked="" type="radio"/>
P07.18	Rated power of the VFD	0.4–3000.0kW		<input checked="" type="radio"/>
P07.19	Rated voltage of the VFD	50–1200 V		<input checked="" type="radio"/>

Function code	Name	Detailed description	Default value	Modify
P07.20	Rated current of the VFD	0.1–6000.0 A		●
P07.21	Factory bar code 1	0x0000–0xFFFF		●
P07.22	Factory bar code 2	0x0000–0xFFFF		●
P07.23	Factory bar code 3	0x0000–0xFFFF		●
P07.24	Factory bar code 4	0x0000–0xFFFF		●
P07.25	Factory bar code 5	0x0000–0xFFFF		●
P07.26	Factory bar code 6	0x0000–0xFFFF		●
P07.27	Type of current fault	1: Inverter unit U phase protection		●
P07.28	Type of last fault	(OUt1)		●
P07.29	Type of last but one fault	2: Inverter unit V phase protection (OUt2)		●
P07.30	Type of last but two fault	3: Inverter unit W phase protection (OUt3)		●
P07.31	Type of last but three fault	4: Overcurrent during acceleration (OC1) 5: Overcurrent during deceleration (OC2) 6: Overcurrent during constant speed (OC3)		●
P07.32	Type of last but four fault	7: Overvoltage during acceleration (OV1) 8: Overvoltage during deceleration (OV2) 9: Overvoltage during constant speed (OV3) 10: Bus undervoltage fault (UV) 11: Motor overload (OL1) 12: VFD overload (OL2) 13: Phase loss on the input side (SPI) 14: Phase loss on the output side (SPO) 15: Rectifier module overheat (OH1) 16: Inverter module overheat (OH2) 17: External fault (EF) 18: 485 communication fault (CE) 19: Current detection fault (ItE) 20: Motor autotuning fault (tE) 21: EEPROM operation fault (EEP) 22: PID feedback disconnection fault (PIDE)		●

Function code	Name	Detailed description	Default value	Modify
		23: Brake unit fault (bCE) 24: Running time reached (END) 25: Electronic overload (OL3) 26: Keypad communication error (PCE) 27: Parameter upload error (UPE) 28: Parameter download error (DNE) 29–31: Reserved 32: To-ground short-circuit fault 1 (ETH1) 33: To-ground short-circuit fault 2 (ETH2) 34: Speed deviation fault (dEu) 35: Mis-adjustment fault (STo) 36: Underload fault (LL) 37: Current limiting fault (LC) (used only by function macro 2) 38: Brake feedback fault (FAE) 39: Torque verification fault (tPF) 40: PT100 overtemperature fault (OtE1) 41: Operating lever fault (StC) 42: Low-speed running protection fault (LSP) 43: Terminal command exception fault (tCE) 44: Terminal command exception at power-on (POE) 45: Set frequency fault (SFE) 46: PTC overtemperature fault (OtE2) 47: Failure to enable the VFD (dIS)		
P07.33	Running frequency at current fault		0.00 Hz	●
P07.34	Ramp frequency reference at current fault		0.00 Hz	●
P07.35	Output voltage at current fault		0 V	●
P07.36	Output current at current fault		0.0 A	●
P07.37	Bus voltage at current fault		0.0 V	●

Function code	Name	Detailed description	Default value	Modify
P07.38	Highest temperature at current fault		0.0℃	●
P07.39	Input terminal state at current fault		0	●
P07.40	Output terminal state at current fault		0	●
P07.41	Running frequency at last fault		0.00 Hz	●
P07.42	Ramp frequency reference at last fault		0.00 Hz	●
P07.43	Output voltage at last fault		0 V	●
P07.44	Output current at last fault		0.0 A	●
P07.45	Bus voltage at last fault		0.0 V	●
P07.46	Highest temperature at last fault		0.0℃	●
P07.47	Input terminal state at last fault		0	●
P07.48	Output terminal state at last fault		0	●
P07.49	Running frequency at last but one fault		0.00 Hz	●
P07.50	Ramp frequency reference at last but one fault		0.00 Hz	●
P07.51	Output voltage at last but one fault		0 V	●
P07.52	Output current at last but one fault		0.0 A	●
P07.53	Bus voltage at last but one fault		0.0 V	●
P07.54	Highest temperature at last but one fault		0.0℃	●
P07.55	Input terminal state at last but one fault		0	●

Function code	Name	Detailed description	Default value	Modify
P07.56	Output terminal state at last but one fault		0	●

P08 group Enhanced functions

Function code	Name	Detailed description	Default value	Modify
P08.00	ACC time 2	0.0–3600.0 s	Depend on model	○
P08.01	DEC time 2	0.0–3600.0 s	Depend on model	○
P08.02	ACC time 3	0.0–3600.0 s	Depend on model	○
P08.03	DEC time 3	0.0–3600.0 s	Depend on model	○
P08.04	ACC time 4	0.0–3600.0 s	Depend on model	○
P08.05	DEC time 4 (Fast stopping time)	0.0–3600.0 s Note: If S terminal selects the fast stop function, it is necessary to set P08.05 (Fast stopping time).	Depend on model	○
P08.06	Running frequency of jogging	0.00–P00.03 (max. output frequency)	5.00 Hz	○
P08.07	ACC time of jogging	0.0–3600.0 s	Depend on model	○
P08.08	DEC time of jogging	0.0–3600.0 s	Depend on model	○
P08.27	Set running time	0–65535 min	0min	○
P08.28	Number of auto fault resets	0–10	0	○
P08.29	Interval setting for auto fault resets	0.1–3600.0 s	1.0 s	○

Function code	Name	Detailed description	Default value	Modify
P08.30	Frequency decrease rate in droop control	-50.00 Hz–50.00 Hz	0.00 Hz	<input type="radio"/>
P08.32	FDT1 level detection value	0.00–P00.03 (max. output frequency)	50.00 Hz	<input type="radio"/>
P08.33	FDT1 lag detection value	0.0–100.0% (FDT1 value)	5.0%	<input type="radio"/>
P08.34	FDT2 level detection value	0.00–P00.03 (max. output frequency)	50.00 Hz	<input type="radio"/>
P08.35	FDT2 lag detection value	0.0–100.0% (FDT2 value)	5.0%	<input type="radio"/>
P08.36	Detection threshold for frequency arrival	0.0–P00.03 (max. output frequency)	0.00 Hz	<input type="radio"/>
P08.37	Enable dynamic braking	0x00–0x11 Ones place: 0: Disable dynamic braking 1: Enable dynamic braking Tens place: 0: Disable braking short circuit protection 1: Enable braking short circuit protection There is no braking short circuit protection for the 22kW and lower VFD models by default.	0x01	<input type="radio"/>
P08.38	Dynamic braking voltage threshold	200.0–2000.0 V	700.0 V	<input type="radio"/>
P08.39	Cooling fan running mode	0: Common running mode 1: Always running after being powered on	0	<input type="radio"/>
P08.40	PWM setting	0x000–0x0021 LED ones place: PWM mode setting 0: PWM mode 1, 3PH modulation and 2PH modulation 1: PWM mode 2, 3PH modulation LED tens place: PWM low-speed carrier limit 0: Limit low-speed carrier, carrier limit mode 1 1: Limit low-speed carrier, carrier limit	0x01	<input checked="" type="radio"/>

Function code	Name	Detailed description	Default value	Modify
		mode 2 2: No limit on low-speed carrier		
P08.41	Overmodulation setting	0x00–0x11 LED ones place: Overmodulation setting 0: Disabled 1: Enabled LED tens place: 0: Light overmodulation 1: Heavy overmodulation	0x00 (4kW and lower VFD models)	◎
			0x01 (5.5kW and higher VFD models)	
P08.42	Keypad digital control setting	0x0000–0x1223 LED ones place: Frequency control setting 0: Adjustment through both the \wedge/\vee key and digital potentiometer is enabled. 1: Only adjustment through the \wedge/\vee key is enabled. 2: Only adjustment through the digital potentiometer is enabled. 3: Adjustment through the \wedge/\vee key or digital potentiometer is disabled. LED tens place: Frequency control setting 0: Valid only when P00.06 is set to 0 or P00.07 is set to 0. 1: All frequency modes are valid. 2: Invalid for multi-step speed when multi-step speed takes precedence. LED hundreds place: Operation preformed during stop 0: The settings are valid. 1: The settings are valid in running and deleted after stop. 2: The settings are valid in running and	0x0000	○

Function code	Name	Detailed description	Default value	Modify
		deleted after a stop command is received. LED thousands place: Integral function of the \wedge / \vee key and digital potentiometer 0: Enabled 1: Disabled		
P08.43	Integral rate of the keypad digital potentiometer	0.01–10.00 s	0.10 s	<input type="radio"/>
P08.44	UP/DOWN terminal control setting	0x000–0x221 LED ones place: Frequency control setting 0: Setting through the UP/DOWN terminal is enabled. 1: Setting through the UP/DOWN terminal is disabled. LED tens place: Frequency control setting 0: Valid only when P00.06 is set to 0 or P00.07 is set to 0. 1: All frequency modes are valid. 2: Invalid for multi-step speed when multi-step speed takes precedence. LED hundreds place: Operation performed during stop 0: The settings are enabled. 1: The settings are enabled in running and deleted after the stop. 2: The settings are enabled in running and deleted after a stop command is received.	0x000	<input type="radio"/>
P08.45	UP terminal frequency incremental integral rate	0.01–50.00 s	0.50 s	<input type="radio"/>
P08.46	DOWN terminal frequency	0.01–50.00 s	0.50 s	<input type="radio"/>

Function code	Name	Detailed description	Default value	Modify
	decrement change rate			
P08.47	Action for frequency settings at power outage	0x000–0x111 LED ones place: Operation performed when power outage occurs in digital adjustment of frequency 0: Saving the settings at power outage 1: Resetting the settings to zero at power outage LED tens place: Operation performed when power outage occurs in frequency setting through Modbus 0: Saving the settings at power outage 1: Resetting the settings to zero at power outage LED hundreds place: Operation performed when power outage occurs in frequency setting through other communication mode 0: Saving the settings at power outage 1: Resetting the settings to zero at power outage	0x000	○
P08.48	MSB of initial power consumption	0–59999 kWh (k)	0 kWh	○
P08.49	LSB of initial power consumption	0.0–999.9 kWh	0.0 kWh	○
P08.50	Magnetic flux braking coefficient	0: Disabled 100–150: A greater coefficient indicates more powerful braking.	0	○
P08.51	Input power factor of the VFD	0.00–1.00	0.56	○

P10 group Multi-step speed control

Function code	Name	Detailed description	Default value	Modify
P10.02	Multi-step speed 0	-100.0–100.0%	0.0%	○
P10.04	Multi-step speed 1	-100.0–100.0%	0.0%	○
P10.06	Multi-step speed 2	-100.0–100.0%	0.0%	○

Function code	Name	Detailed description	Default value	Modify
P10.08	Multi-step speed 3	-100.0–100.0%	0.0%	<input type="radio"/>
P10.10	Multi-step speed 4	-100.0–100.0%	0.0%	<input type="radio"/>
P10.12	Multi-step speed 5	-100.0–100.0%	0.0%	<input type="radio"/>
P10.14	Multi-step speed 6	-100.0–100.0%	0.0%	<input type="radio"/>
P10.16	Multi-step speed 7	-100.0–100.0%	0.0%	<input type="radio"/>
P10.18	Multi-step speed 8	-100.0–100.0%	0.0%	<input type="radio"/>
P10.20	Multi-step speed 9	-100.0–100.0%	0.0%	<input type="radio"/>
P10.22	Multi-step speed 10	-100.0–100.0%	0.0%	<input type="radio"/>
P10.24	Multi-step speed 11	-100.0–100.0%	0.0%	<input type="radio"/>
P10.26	Multi-step speed 12	-100.0–100.0%	0.0%	<input type="radio"/>
P10.28	Multi-step speed 13	-100.0–100.0%	0.0%	<input type="radio"/>
P10.30	Multi-step speed 14	-100.0–100.0%	0.0%	<input type="radio"/>
P10.32	Multi-step speed 15	-100.0–100.0%	0.0%	<input type="radio"/>

P11 group Protective parameters

Function code	Name	Detailed description	Default value	Modify
P11.00	Phase loss protection	0x0000–0x1111 LED ones place: 0: Disable input phase loss software protection 1: Enable input phase loss software protection LED tens place: 0: Disable output phase loss software protection 1: Enable output phase loss software protection LED hundreds place: 0: Disable input phase loss hardware protection 1: Enable input phase loss hardware protection LED thousands place: 0: During stop, if a hardware input phase loss fault occurs, it reports SPI. 1: During stop, if a hardware input phase loss fault occurs, it reports A-SPI.	0010 (4kW and lower VFD models) 0110 (5.5kW and higher VFD models)	<input type="radio"/>

Function code	Name	Detailed description	Default value	Modify
P11.01	Frequency decrease at momentary power outage	0: Disabled 1: Enabled	0	<input type="radio"/>
P11.02	Frequency decrease rate at momentary power outage	0.00 Hz–P00.03/s (max. output frequency)	10.00Hz /s	<input type="radio"/>
P11.03	Overvoltage stall protection	0: Disabled 1: Enabled	0	<input type="radio"/>
P11.04	Overvoltage stall protection threshold	110–150% (of the standard bus voltage)	136%	<input type="radio"/>
P11.05	Current limiting setting	0x00–0x12 Ones place: Current-limit action setting 0: Disabled 1: Always enabled 2: Disabled during deceleration Tens place: Hardware current-limit overload alarm setting 0: Disabled 1: Enabled	0x10	<input checked="" type="radio"/>
P11.06	Auto current limiting threshold	50.0–200.0%	160.0%	<input checked="" type="radio"/>
P11.07	Frequency decrease rate in current limiting	0.00–50.00 Hz/s	10.00 Hz/s	<input checked="" type="radio"/>
P11.08	VFD/motor overload/underload pre-alarm setting	0x000–0x131 LED ones place: 0: Overload/underload pre-alarm for the motor, relative to the rated current of the motor 1: Overload/underload pre-alarm for the VFD, relative to the rated current of the VFD LED tens place: 0: The VFD continues to run after an overload/underload pre-alarm is generated. 1: The VFD continues to run after an	0x000	<input type="radio"/>

Function code	Name	Detailed description	Default value	Modify
		<p>underload pre-alarm is generated, and stops after an overload fault is reported.</p> <p>2: The VFD continues to run after an overload pre-alarm is generated, and stops after an underload fault is reported.</p> <p>3: The VFD stops after an overload/underload fault is reported.</p> <p>LED hundreds place:</p> <p>0: Always detecting</p> <p>1: Detecting in constant-speed running</p>		
P11.09	Overload pre-alarm generation threshold	P11.11–200%	150%	<input type="radio"/>
P11.10	Overload pre-alarm generation time threshold	0.1–3600.0 s	1.0 s	<input type="radio"/>
P11.11	Underload pre-alarm generation threshold	0%–P11.09	25%	<input type="radio"/>
P11.12	Underload pre-alarm generation time threshold	0.01–360.00 s	0.05 s	<input type="radio"/>
P11.13	Action of fault output terminal at fault	<p>0x00–0x11</p> <p>LED ones place:</p> <p>0: Acting at undervoltage fault</p> <p>1: Not acting at undervoltage fault</p> <p>LED tens place:</p> <p>0: Acting at automatic fault reset</p> <p>1: Not acting at automatic fault reset</p>	0x00	<input type="radio"/>
P11.14	Speed deviation threshold	0.0–50.0%	10.0%	<input type="radio"/>
P11.15	Speed deviation time threshold	0.0–10.0 s (When P11.15 is set to 0.0, speed deviation protection is disabled.)	0.5 s	<input type="radio"/>
P11.16	Extension functions	<p>0x00–0x11</p> <p>LED ones place:</p> <p>0–1: Reserved</p> <p>LED tens place: ACC/DEC time 2 setting</p> <p>0: Disabled</p> <p>1: Enabled. When the VFD runs at the</p>	00	<input type="radio"/>

Function code	Name	Detailed description	Default value	Modify
		frequency higher than set by P08.36, switches to ACC/DEC time 2.		

P14 group Serial communication functions

Function code	Name	Detailed description	Default value	Modify
P14.00	Communication address	1–247; 0 indicates a broadcast address	1	<input type="radio"/>
P14.01	Communication baud rate	0: 1200BPS 1: 2400BPS 2: 4800BPS 3: 9600BPS 4: 19200BPS 5: 38400BPS 6: 57600BPS	4	<input type="radio"/>
P14.02	Data bit check setting	0: No parity check (N, 8, 1) for RTU 1: Even parity check (E, 8, 1) for RTU 2: Odd parity check (O, 8, 1) for RTU 3: No parity check (N, 8, 2) for RTU 4: Even parity check (E, 8, 2) for RTU 5: Odd parity check (O, 8, 2) for RTU 6: No parity check (N, 7, 1) for ASCII 7: Even parity check (E, 7, 1) for ASCII 8: Odd parity check (O, 7, 1) for ASCII 9: No parity check (N, 7, 2) for ASCII 10: Even parity check (E, 7, 2) for ASCII 11: Odd parity check (O, 7, 2) for ASCII 12: No parity check (N, 8, 1) for ASCII 13: Even parity check (E, 8, 1) for ASCII 14: Odd parity check (O, 8, 1) for ASCII 15: No parity check (N, 8, 2) for ASCII 16: Even parity check (E, 8, 2) for ASCII 17: Odd parity check (O, 8, 2) for ASCII	1	<input type="radio"/>
P14.03	Communication response delay	0–200ms	5	<input type="radio"/>
P14.04	Communication timeout period	0.0 (invalid); 0.1–60.0 s	0.0 s	<input type="radio"/>
P14.05	Transmission error	0: Alarm and coast to stop	0	<input type="radio"/>

Function code	Name	Detailed description	Default value	Modify
	processing	1: Do not alarm and continue running 2: Do not alarm and stop as per the stop mode (under communication control mode only) 3: Do not alarm and stop as per the stop mode (under all control modes)		
P14.06	Communication processing action	0x00–0x11 LED ones place: 0: Write operation has response 1: Write operation has no response LED tens place: 0: Communication encryption is disabled 1: Communication encryption is enabled	0x00	○

P17 group State viewing functions

Function code	Name	Detailed description	Default value	Modify
P17.00	Set frequency	0.00 Hz–P00.03	0.00 Hz	●
P17.01	Output frequency	0.00 Hz–P00.03	0.00 Hz	●
P17.02	Ramp frequency reference	0.00 Hz–P00.03	0.00 Hz	●
P17.03	Output voltage	0–1200 V	0 V	●
P17.04	Output current	0.0–5000.0 A	0.0 A	●
P17.05	Rotating speed of the motor	0–65535 RPM	0 RPM	●
P17.06	Torque current	0.0–5000.0 A	0.0 A	●
P17.07	Excitation current	0.0–5000.0 A	0.0 A	●
P17.08	Power of the motor	-300.0–+300.0% (of the rated power of the motor)	0.0%	●
P17.09	Output torque	-250.0–250.0%	0.0%	●
P17.10	Estimated frequency of the motor	0.00–P00.03	0.00 Hz	●
P17.11	DC bus voltage	0.0–2000.0 V	0 V	●
P17.12	Digital input terminal state	0000–00FF	0	●
P17.13	Digital output terminal state	0000–000F	0	●
P17.14	Digital adjustment	0.00 Hz–P00.03	0.00 V	●

Function code	Name	Detailed description	Default value	Modify
P17.15	Torque reference	-300.0%→+300.0% (of the rated current of the motor)	0.0%	●
P17.16	Linear speed	0-65535	0	●
P17.19	AI1 input voltage	0.00-10.00 V	0.00 V	●
P17.20	AI2 input voltage	0.00-10.00 V	0.00 V	●
P17.25	Motor power factor	-1.00-1.00	0.0	●
P17.26	Period of current running	0-65535m	0m	●
P17.28	ASR controller output	-300.0%→+300.0% (of the rated current of the motor)	0.0%	●
P17.29	Light-load speed boost status	0-2 0: Normal 1: Forward light-load speed boost 2: Reverse light-load speed boost	0	●
P17.30	Status of derating frequency with voltage	0-1 0: Normal 1: Derating frequency with voltage	0	●
P17.31	DEC limit mode	0-1 0: Normal 1: Speed limiting	0	●
P17.32	Flux linkage	0.0%-200.0%	0.0%	●
P17.33	Excitation current reference	-3000.0-3000.0 A	0.0 A	●
P17.34	Torque current reference	-3000.0-3000.0 A	0.0 A	●
P17.35	AC incoming current	0.0-5000.0 A	0.0 A	●
P17.36	Output torque	-3000.0 Nm-3000.0 Nm	0.0 Nm	●
P17.37	Motor overload counting	0-100 (OL1 is reported when the count value reaches 100)	0	●
P17.39	Function code of the parameter download error	0.00-29.00	0.00	●
P17.40	Load current detection value at light-load acceleration	0.0-150.0%	0.0%	●
P17.41	Present temperature	-50.0-200.0°C	0.0°C	●

Function code	Name	Detailed description	Default value	Modify
	of PT100			
P17.42	Present digital value of PT100	0-5000	0	●
P17.43	Displayed alarm code	0-5 0: No alarm 1: Overload (A-OL) 2: Undervoltage (A-LvP) 3: Upward position limit reached (A-LU) 4: Downward position limit reached (A-Ld) 5: PT100 disconnection (A-Pt) 6: PT100 overtemperature (A-Ot) 7: PTC overtemperature (A-PTC) 8: Input phase loss (A-SPI) 9: Set frequency before brake release less than brake release frequency (A-SSF) 10: Set frequency after brake release less than brake closing frequency (A-rSF)	0	●

P19 group Simple Hoisting functions

Function code	Name	Detailed description	Default value	Modify
P19.00	Application macros	0 - 5 0: Common mode 1: Lifting mode 1 (in open-loop vector control) 2: Lifting mode 2 (in space voltage vector control) 3: Horizontal moving application mode 4: Reserved 5: Conical motor mode	1	◎
P19.01	Brake control	0: Do not control the brake 1: Brake is controlled by the VFD	0	◎
P19.02	Conical motor function enabling	0: Disable 1: Enable	0	◎
P19.03	Excitation increase	External brake is not required for the	120.0%	○

Function code	Name	Detailed description	Default value	Modify
	coefficient K1 of the conical motor	conical motor. The conical motor can achieve brake action through flux control inside the motor. When the motor starts, the start frequency shall be slightly increased to realize the brake opening. When the motor stops, fast demagnetization is needed to prevent slipping caused by brake closing not timely.		
P19.04	Excitation constant coefficient K2 of the conical motor		100.0%	<input type="radio"/>
P19.05	Excitation decrease coefficient K3 of the conical motor	<p>It is used when the conical motor function is different from the multi-dot V/F.</p> <p>The top graph shows Output frequency vs Time t. The frequency starts at a low value, rises to a peak (labeled 'Rated frequency'), remains constant for a period, and then falls back to the low value. The bottom graph shows Output voltage V (%) vs Time t. The voltage starts at a low value, rises to a peak (labeled 'P19.03'), remains constant for a period, and then falls back to the low value. The voltage graph also shows 'Torque boost voltage (%)' and 'Start command' and 'Brake action' signals. Parameters P19.04 and P19.05 are indicated on the voltage graph.</p>	80.0%	<input type="radio"/>
		<p>It is used when the conical motor</p> <p>The graph shows Output frequency vs Time t. The frequency starts at a low value, rises to a peak (labeled 'Rated frequency'), remains constant for a period, and then falls back to the low value. The graph also shows 'Output voltage V (%)' and 'Start command' and 'Brake action' signals. Parameters P04.07, P04.05, and P04.03 are indicated on the frequency graph.</p>		

Function code	Name	Detailed description	Default value	Modify																																																	
		function is the same as the multi-dot V/F. Note: 1. The torque boost voltage is related to P04.01. 2. I/F is invalid to conical motor application. Setting range of P19.03: P19.03–150.0% (100.0% corresponds to the rated voltage of the motor) Setting range of P19.04: P19.05–P19.03 Setting range of P19.05: 0.0–P19.04																																																			
P19.06	Graded multi-step speed reference 0	Graded reference is a kind of speed reference method designed specifically for the crane application mode (graded operating lever mode/graded remote control mode), which can support up to six graded speeds through the combination of five graded multi-step reference terminals. The combination mode is shown in the following table. Graded reference terminals	0.0%	<input type="radio"/>																																																	
P19.07	Graded multi-step speed reference 1		0.0%	<input type="radio"/>																																																	
P19.08	Graded multi-step speed reference 2		0.0%	<input type="radio"/>																																																	
P19.09	Graded multi-step speed reference 3		0.0%	<input type="radio"/>																																																	
P19.10	Graded multi-step speed reference 4		0.0%	<input type="radio"/>																																																	
P19.11	Graded multi-step speed reference 5	<table border="1"> <thead> <tr> <th>Terminal 1</th> <th>Terminal 2</th> <th>Terminal 3</th> <th>Terminal 4</th> <th>Terminal 5</th> <th>Speed setting</th> <th>Function code</th> </tr> </thead> <tbody> <tr> <td>OFF</td> <td>OFF</td> <td>OFF</td> <td>OFF</td> <td>OFF</td> <td>Graded setting 0</td> <td>P19.06</td> </tr> <tr> <td>ON</td> <td>OFF</td> <td>OFF</td> <td>OFF</td> <td>OFF</td> <td>Graded setting 1</td> <td>P19.07</td> </tr> <tr> <td>ON</td> <td>ON</td> <td>OFF</td> <td>OFF</td> <td>OFF</td> <td>Graded setting 2</td> <td>P19.08</td> </tr> <tr> <td>ON</td> <td>ON</td> <td>ON</td> <td>OFF</td> <td>OFF</td> <td>Graded setting 3</td> <td>P19.09</td> </tr> <tr> <td>ON</td> <td>ON</td> <td>ON</td> <td>ON</td> <td>OFF</td> <td>Graded setting 4</td> <td>P19.10</td> </tr> <tr> <td>ON</td> <td>ON</td> <td>ON</td> <td>ON</td> <td>ON</td> <td>Graded setting 5</td> <td>P19.11</td> </tr> </tbody> </table>	Terminal 1	Terminal 2	Terminal 3	Terminal 4	Terminal 5	Speed setting	Function code	OFF	OFF	OFF	OFF	OFF	Graded setting 0	P19.06	ON	OFF	OFF	OFF	OFF	Graded setting 1	P19.07	ON	ON	OFF	OFF	OFF	Graded setting 2	P19.08	ON	ON	ON	OFF	OFF	Graded setting 3	P19.09	ON	ON	ON	ON	OFF	Graded setting 4	P19.10	ON	ON	ON	ON	ON	Graded setting 5	P19.11	0.0%	<input type="radio"/>
		Terminal 1	Terminal 2	Terminal 3	Terminal 4	Terminal 5	Speed setting	Function code																																													
		OFF	OFF	OFF	OFF	OFF	Graded setting 0	P19.06																																													
		ON	OFF	OFF	OFF	OFF	Graded setting 1	P19.07																																													
		ON	ON	OFF	OFF	OFF	Graded setting 2	P19.08																																													
		ON	ON	ON	OFF	OFF	Graded setting 3	P19.09																																													
		ON	ON	ON	ON	OFF	Graded setting 4	P19.10																																													
ON	ON	ON	ON	ON	Graded setting 5	P19.11																																															
Set the speed reference to graded multi-step speed reference mode																																																					

Function code	Name	Detailed description	Default value	Modify
		(P00.06=13 or P00.07=13). Graded terminal reference is determined by the combination of P05 group input terminal function 61-65 (Graded reference terminal 1-5), and speed is set by P19.06-P19.11 (percentage of the max. output frequency P00.03) Setting range of P19.06, P19.07, P19.08, P19.09, P19.10, and P19.11: 0.0-100.0% Note: The higher-level graded reference can be switched on only after the lower-level ones are switched on. Otherwise, the graded reference is disabled.		
P19.12	Forward brake release frequency	Brake sequence diagram of forward and reverse running special for hoisting is shown in the following figure. <p> T1: Delay before brake release P19.18 T3: Delay before brake closing P19.21 T2: Delay after forward brake release P19.19 T4: Delay after brake closing P19.22 T5: Delay after reverse brake release P19.20 T0: Maintenance frequency hold time during DEC P19.46 </p>	3.00	⊙
P19.13	Forward brake release current		0.0%	⊙
P19.14	Forward brake closing frequency		3.00	⊙
P19.15	Reverse brake release frequency		3.00	⊙
P19.16	Reverse brake release current		0.0%	⊙
P19.17	Reverse brake closing frequency		2.50	⊙
P19.18	Delay before brake release		0.300 s	⊙
P19.19	Delay after brake release for forward-running start		0.150 s	⊙
P19.20	Delay after brake release for reverse-running start		0.150 s	⊙
P19.21	Delay before brake closing at stop	0.150 s	⊙	

Function code	Name	Detailed description	Default value	Modify
P19.22	Delay after brake closing at stop	<p>direction, it is needed to give upward running command first. The VFD rotates in the forward direction until P19.15 is reached. Then timing starts and lasts until the P19.18 (T1) is reached, and torque verification is passed, the VFD outputs the brake release signal. After P19.20 (T5) is reached, the VFD switches to the downward target frequency, and runs normally.</p> <p>For stopping in the downward running direction, if P19.46 is a non-zero value, the VFD decelerates to P19.45 and lasts for P19.46, and then decelerates in downward direction for switching to the upward running direction. Timing starts when the VFD rotates in the upward direction until P19.17 is reached, and lasts until P19.21 (T3) is reached, the VFD outputs the brake closing signal. After P19.22 (T4) is reached, the VFD stops.</p> <p>Setting range of P19.12: 0.00–20.00 Hz Setting range of P19.13: 0.0%–200.0% (of the rated current of the motor) Setting range of P19.14: 0.00–20.00 Hz Setting range of P19.15: 0.00–20.00 Hz Setting range of P19.16: 0.0%–200.0% (of the rated current of the motor) Setting range of P19.17: 0.00–20.00 Hz Setting range of P19.18: 0.000–5.000 s Setting range of P19.19: 0.000–5.000 s Setting range of P19.20: 0.000–5.000 s Setting range of P19.21: 0.000–5.000 s Setting range of P19.22: 0.000–5.000 s</p>	0.300 s	◎
P19.24	Brake feedback detection time	0.00–20.000 s Brake feedback detection time (P19.24) is used together with P05 group input	1.000s	◎

Function code	Name	Detailed description	Default value	Modify
		terminal function 59 (Brake feedback signal). If the terminal input function is set to 59, it indicates that brake feedback function is enabled. After the brake is released, if no brake feedback signal is detected in the brake feedback detection time, a brake feedback fault (FAE) is reported when P19.24 is reached.		
P19.26	Torque verification fault detection time	0.00–10.000 s If the set value of the torque verification current is a non-zero value, that is, the torque verification function is enabled. After the VFD runs, if the output current of the VFD is less than the set value and the lasting time is greater than torque verification fault detection time (P19.26), the VFD will stop due to the torque verification fault, and torque verification fault (TPF) will be displayed on the keypad.	3.000s	⊙
P19.27	Forward brake release torque	0.0–200.0% (of the rated torque of the motor)	0.0%	⊙
P19.28	Reverse brake release torque	0.0–200.0% (of the rated torque of the motor)	0.0%	⊙
P19.29	Light-load speed boost enabling	0–2 0: Disable 1: Enable light-load speed boost 2: Light-load speed boost signal given by external terminal	0	⊙
P19.30	Light-load speed-boost detection frequency	<p>The figure consists of two vertically aligned graphs sharing a common horizontal time axis. The top graph plots Output frequency against Time. It shows a ramp-up from the Rated frequency of motor to a Set frequency (P19.34). After a certain point, the frequency continues to rise to a higher level labeled 'Light-load speed boost after current verification success'. A horizontal dashed line at the top of this second ramp is labeled P19.31. The bottom graph plots Output current against Time. It shows a peak in current during the initial ramp-up, followed by a drop and then a steady-state level labeled 'Light-load speed boost after current verification success'. A horizontal dashed line at this level is labeled P19.32 or P19.33.</p>	40.00Hz	⊙
P19.31	Light-load speed-boost current detection time		1.000s	⊙
P19.32	Forward light-load speed-boost current detection value		60.0%	⊙
P19.33	Reverse light-load		40.0%	⊙

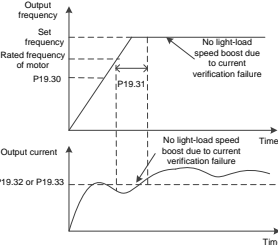
Function code	Name	Detailed description	Default value	Modify
	speed-boost current detection value	<p data-bbox="398 168 760 215">Light-load speed boost after current verification success</p>  <p data-bbox="376 554 783 601">No light-load speed boost due to current verification failure</p> <p data-bbox="376 608 783 630">When P19.29 is 1, light-load speed boost function is enabled. Processing for light-load speed boost is performed only when the set frequency is no less than P02.02 (Rated frequency of the motor). After running, if the ramp frequency is equal to or greater than P19.30, current is detected and count starts. When P91.31 is reached, if the current is less than P19.32 (or P19.33 in reverse running), the current detection passes, the VFD increases the frequency to P19.34. If the current detection fails, the VFD remains the original frequency.</p> <p data-bbox="376 1045 783 1191">When P19.29 is 2, select terminal function 70: Light-load speed boost signal. When this terminal is valid, the VFD increases the frequency to the value set in P19.34.</p> <p data-bbox="376 1198 783 1253">Setting range of P19.30: 30.00 Hz–P02.02</p> <p data-bbox="376 1260 760 1282">Setting range of P19.31: 0.0 – 10.000s</p> <p data-bbox="376 1290 760 1311">Setting range of P19.32: 0.0 – 150.0%</p> <p data-bbox="376 1319 760 1340">Setting range of P19.33: 0.0 – 150.0%</p>		

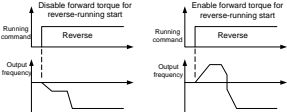
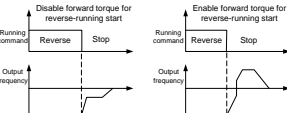
Function code	Name	Detailed description	Default value	Modify
P19.34	Target frequency setting of light-load speed boost	0.00–100.00Hz	70.00 Hz	☉
P19.35	Reverse-running start direction	<p>0: The reverse-running start direction complies with the running direction 1: The reverse-running start direction is always the forward-running direction When function is enabled, the VFD will first run in forward direction and then run in reverse direction.</p> 	0	☉
P19.36	Reverse-running stop direction	<p>0: The reverse-running stop direction complies with the running direction 1: The reverse-running stop direction is always the forward-running direction</p> 	0	☉
P19.37	Enabling operating lever zero point position detection	Setting range of P19.37: 0–1 0: Disable	0	☉
P19.38	Operating lever zero point position delay	1: Enable	0.300s	☉

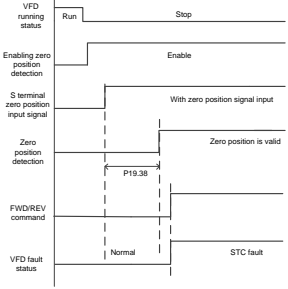
Function code	Name	Detailed description	Default value	Modify
		 <p>When P19.37=1, P19.37 can be used together with P05 group input terminal function 60 (Operating lever zero-point position signal) to conduct operating lever zero-point position detection. When the VFD stops, if the operating lever zero-point position signal is enabled (operating lever zeroing), timing starts. At this moment, if operating lever upward or downward running command exits, the VFD does not respond to the command, but if P19.38 is reached, an operating lever fault (StC) will be reported. If the counting time reaches P19.38, it indicates that the zero position is detected successfully. The zero position signal is released, and the VFD responds only after being given with the operating lever upward/downward command. In the situation that the zero position signal is not released, if the operating lever upward/downward command is given, an operating lever fault (StC) will be reported. (For the operating lever, it is forbidden to enable multiple operating lever positions</p>		

Function code	Name	Detailed description	Default value	Modify
		<p>simultaneously, otherwise, it will be considered as an operation exception. That is to say, after the VFD stops, the operating lever zeroing starts timing and lasts until P19.38 is reached. Valid running command can be given again only when the zero position is detected successfully.</p> <p>Setting range of P19.38: 0.000–60.000 s</p>		
P19.39	Jogging brake release type	<p>0: Same as brake release frequency 1: Same as jogging frequency</p> <p>Select forward/reverse brake release frequency (P19.12/P19.15) when P19.39=0.</p> <p>Select jogging frequency (P08.06) is adopted when P19.39=1.</p>	0	⊙
P19.40	Jogging brake closing type	<p>0: Same as brake release frequency 1: Same as jogging frequency</p> <p>Select forward/reverse brake closing frequency (P19.14/P19.17) when P19.40=0.</p> <p>Select jogging frequency (P08.06) is adopted when P19.40=1.</p>	0	⊙
P19.41	Brake selection for forward/reverse switchover	<p>0: Perform switchover without braking 1: Perform switchover with braking</p> <p>When P19.41=0, the switchover is performed directly, and the brake does</p>	0	⊙

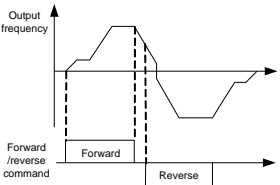
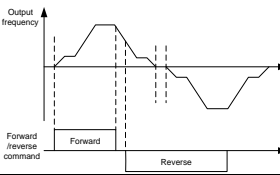
Function code	Name	Detailed description	Default value	Modify
		<p>not act.</p>  <p>When P19.41=1, during the switchover, the VFD decelerates with braking to stop, and then opens the brake to run in reverse direction.</p>		
P19.42	Restart selection during braking	Setting range of P19.42: 0–1 0: No restart during braking	0	☉
P19.43	Wait time of restart	 <p>If the brake closing command has been output during stop, the VFD doesn't accept a new start command, and starts after waiting until the brake closing is completed, the VFD stops, and time set in P19.43 is reached.</p> <p>1: Restart allowed during braking</p>	0.5s	☉

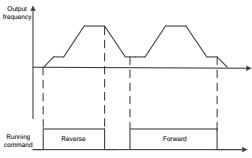
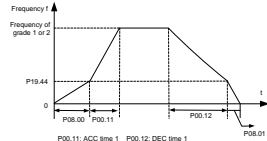
Function code	Name	Detailed description	Default value	Modify
		 <p>Though the brake closing command has been output during stop, the VFD accepts a new start command. Though the brake closing command has been output during stop, the VFD accepts a new start command. Setting range of P19.43: 0.0–10.0s</p>		
P19.44	Frequency threshold for switching ACC/DEC time	<p>0.00–50.00 Hz</p> <p>If the ramp frequency is equal to or greater than P19.44, ACC/DEC time 1 is used; if it is less than P19.44, ACC/DEC time 2 is used.</p>  <p>P00.11: ACC time 1 P00.12: DEC time 1 P08.00: ACC time 2 P08.01: DEC time 2 P19.44: Frequency threshold for switching ACC/DEC time</p>	0.00Hz	⊙
P19.45	Hold frequency during the forward torque deceleration	During the process of stopping, the VFD can decelerate to the hold frequency set in P19.45 first, and last for the hold time set in P19.46 before stopping.	5.00Hz	⊙
P19.46	Hold time for frequency maintained during the forward torque deceleration	When P19.46=0, it indicates that the hold frequency doesn't work. Setting range of P19.45: 0.00–50.00 Hz Setting range of P19.46: 0.00–5.000 s	0.000s	⊙
P19.47	Detection threshold for speed deviation	Setting range of P19.47: 0.0–50.0% (relative to P00.03)	5.0%	⊙

Function code	Name	Detailed description	Default value	Modify
P19.48	In VF mode (current-limiting protection) Detection time for speed deviation in VF mode	<p>When the difference between the ramp frequency and output frequency is equal to or greater than the deviation detection value set in P19.47, a speed deviation fault is reported.</p> <p>0.0–10.0 s (no current-limiting protection is performed when the set value is 0.0)</p> <p><small>Frg_out: Output frequency (P17.01) Frg2: Ramp frequency (P17.02)</small></p>	0.5s	⊙

P27 group Hoisting protection function

Function code	Name	Detailed description	Default value	Modify
P27.00	Low voltage protection enabling	Setting range of P27.00: 0–1 0: Disable 1: Enable	0	○
P27.01	Low voltage protection threshold	<p>Setting range of P27.01: 1.00–1.30</p> <p>After P27.00 is enabled, if the bus voltage is less than (P27.01 × rated voltage of the motor), the low voltage protection function is started, the VFD decelerates to stop, and simultaneously reports low voltage protection alarm (A-LvP).</p> <p>If the bus voltage restores to a value greater than (P27.01 × rated voltage of the motor) +20 V, low voltage protection function is automatically disabled.</p>	1.05	○

Function code	Name	Detailed description	Default value	Modify
P27.02	Enable frequency derating with voltage	Setting range of P27.02: 0-1 0: Disable 1: Enable	0	<input type="radio"/>
P27.03	Starting voltage of derating frequency with voltage	Setting range of P27.03: 70.0%–95.0% (standard bus voltage 513V) After P27.02 is enabled, frequency derating is performed when the bus voltage is less than the value ($P27.03 \times \text{standard bus voltage}$). You can view the state of derating frequency with voltage through P17.30 or select frequency derating with voltage through relay output function. If the bus voltage restores to a value greater than $(P27.03 + 5.0\%) \times \text{standard bus voltage}$, the frequency is restored to a normal state.	85.0%	<input type="radio"/>
P27.04	Overload protection	When P92.04 is greater than 0, overload	0.0%	

Function code	Name	Detailed description	Default value	Modify
	current detection value	protection is enabled. If the ramp frequency is equal to or greater than (P19.12+2.00Hz) during upward running, the VFD starts checking the output current. If the current is equal to or greater than P27.04, the VFD reports the overload protection alarm (A-OL) after the detection time reaches P27.05. This restriction is not applicable to downward running.		
P27.05	Overload detection time	Setting range of P27.04: 0.0–150.0% (of the rated torque of the motor. When the value is set to 0, P27.04 is disabled) Setting range of P27.05: 0.0–5.0 s		
P27.06	PT100 overtemperature protection threshold	0.0–150.0°C	120.0°C	<input type="radio"/>
P27.07	PT100 overtemperature prealarm threshold	0.0–P27.06	100.0°C	<input type="radio"/>
P27.08	Upper limit of PT100 calibration temperature	50.0–150.0°C	150.0°C	<input type="radio"/>
P27.09	Lower limit of PT100 calibration temperature	-20.0–50.0°C	-20.0°C	<input type="radio"/>
P27.10	Digital value of PT100 calibration upper limit	0–4096	4096	<input type="radio"/>
P27.11	Digital value of PT100 calibration lower limit	0–4096	0	<input type="radio"/>
P27.12	PT100 disconnection detection enabling	0–1 0: Disable 1: Enable When PT100 is connected, PT100 automatically enables P17.41 to display	0	<input type="radio"/>

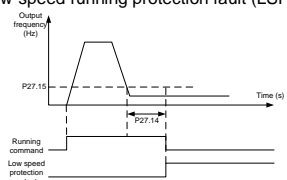
Function code	Name	Detailed description	Default value	Modify
		the temperature value. If the display value of P17.42 is greater than 4000, and P27.12 is enabled, an alarm (A-Pt) will be reported.		
P27.13	Terminal input current mode	0-1 0: DC input 1: AC input	0	○
P27.14	Low-speed running protection time	When P27.14 is a non-zero value, low-speed running protection is enabled. If the running frequency of the VFD is equal to or less than the frequency set in P27.15, and the lasting running time is equal to or greater than the protection time set in P27.14, the VFD reports a low-speed running protection fault (LSP).		
P27.15	Setting of low-speed running frequency	 <p>Setting range of P27.14: 0.000-50.000 s Setting range of P27.15: 0.00-20.00 Hz</p>		
P27.16	DEC position limit mode	0-1 0: Uni-directional speed limit 1: Bi-directional speed limit	0	◎

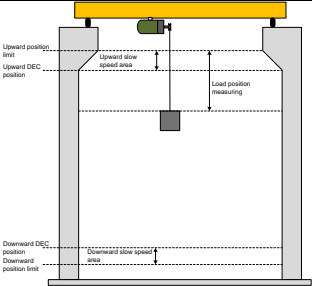
Function code	Name	Detailed description	Default value	Modify
		 <p>Uni-directional speed limit: The upward DEC position limit restricts the upward running speed, but not downward running speed. Downward ACC position limit uses the similar rule.</p> <p>Bi-directional speed limit: The upward DEC position limit restricts both the upward running speed and the downward running speed. Downward DEC position limit uses the similar rule. If bi-directional speed limit is selected, upward and downware DEC position limit can be connected to the same S terminal, that is, when the terminal is valid, the value set in P27.17 is reached, and one S terminal is omitted. (Terminal command mode)</p>		
P27.17	DEC position limit restricted frequency	0.00–20.00Hz	10.00Hz	<input type="radio"/>
P27.18	Reference frequency detection enabling	0–1 0: Disable 1: Enable	0	<input checked="" type="radio"/>
P27.19	Protection frequency for reference frequency exception	0.00–20.00 Hz Set P27.18 to 1 to enable the reference frequency detection. If the set frequency is less than the value set in P27.19, a	3.00Hz	<input type="radio"/>

Function code	Name	Detailed description	Default value	Modify
		fault (SFE) will be reported.		
P27.20	PTC overtemperature selection	0-1 0: The PTC function is valid through terminal selection, the PTC overtemperature alarm A-Ptc is reported, but the machine still runs properly. 1: The PTC function is valid through terminal selection, the PTC overtemperature fault PtcE is reported, but the machine stops.	0	○

7 Fault tracking

7.1 Fault prevention

This chapter describes how to carry out preventive maintenance on Goodrive20-09 series VFDs.

7.1.1 Periodical inspection

If the VFD is installed in an environment that meets requirements, little maintenance is needed. The following table describes the routine maintenance periods recommended by INVT. For more detailed information on maintenance, please contact us.

Inspection target		Item	Method	Criterion
Ambient environment		Check the temperature, and humidity, and whether there is vibration, dust, gas, oil spray, and water droplets in the environment.	Visual inspection, and use instruments for measurement.	The requirements stated in this manual are met.
		Check whether there are foreign matters, such as tools, or dangerous substances placed nearby.	Visual inspection	There are no tools or dangerous substances placed nearby.
Voltage		Check the voltage of the main circuit and control circuit.	Using multimeters or other instruments for measurement.	The requirements stated in this manual are met.
Keypad		Check whether the display of information is clear.	Visual inspection	The characters are displayed properly.
		Check whether characters are not completely displayed.	Visual inspection	The requirements stated in this manual are met.
Main circuit	Common	Check whether the bolts loose or come off.	Screwing them up.	No exception occurs.
		Check whether the machine or insulators are deformed, cracked, or damaged, or their color changes due to	Visual inspection	No exception occurs.

Inspection target	Item	Method	Criterion
	overheating and aging. Check whether there are stains and dust attached.	Visual inspection	No exception occurs. Note: Discoloration of copper bars does not mean that they cannot work properly.
Conductor and wire	Check whether the conductors are deformed or their color changes due to overheating.	Visual inspection	No exception occurs.
	Check whether the wire sheaths are cracked or their color changes.	Visual inspection	No exception occurs.
Terminal block	Check whether there is damage.	Visual inspection	No exception occurs.
Filtering capacitor	Check whether there is electrolyte leakage, discoloration, cracks, or chassis expansion.	Visual inspection	No exception occurs.
	Check whether the safety valves are released.	Determining the service life based on the maintenance information, or measuring them through electrostatic capacity.	No exception occurs.
	Check whether the electrostatic capacity meets the requirements.	Using instruments to measure the capacity	Electrostatic capacity \geq initial value \times 0.85
Resistor	Check whether there is displacement due to overheating.	Olfactory and visual inspection	No exception occurs.
	Check whether the resistors are disconnected.	Using a multimeter for	Resistance range: $\pm 10\%$ (of

Inspection target		Item	Method	Criterion
			measurement	the standard resistance)
	Transformer, reactor	Check whether there is unusual vibration sounds or smells.	Auditory, olfactory, and visual inspection	No exception occurs.
	Electromagnetic contactor, relay	Check whether there are vibration sounds during operation.	Auditory inspection	No exception occurs.
Check whether the contacts are in good contact.		Visual inspection	No exception occurs.	
Control circuit	Control PCB, connector	Check whether the screws and connectors loose.	Screwing them up.	No exception occurs.
		Check whether there is unusual smell or discoloration.	Olfactory and visual inspection	No exception occurs.
		Check whether there are cracks, damage, deformation, or rust.	Visual inspection	No exception occurs.
		Check whether there is electrolyte leakage or deformation.	Visual inspection, and determining the service life based on the maintenance instruction	No exception occurs.
Cooling system	Cooling fan	Check whether there are unusual sounds or vibration.	Auditory and visual inspection, and turn the fan blades with your hand.	The rotation is smooth.
		Check whether the bolts loose.	Screwing them up.	No exception occurs.
		Check whether there is decoloration caused due to overheating.	Visual inspection, and determining the service life	No exception occurs.

Inspection target		Item	Method	Criterion
			based on the maintenance instruction	
	Ventilation duct	Check whether there are foreign matters blocking or attached to the cooling fan, air inlets, or air outlets.	Visual inspection	No exception occurs.

7.1.2 Cooling fan

The service life of the cooling fan of the VFD is more than 25,000 hours. The actual service life is related to the use of the VFD and the temperature in the ambient environment. You can view the running duration of the VFD through P07.14 (Accumulated running time).

The increase of the bearing noise indicates a fan fault. If the VFD is applied in a key position, replace the fan once the fan starts to generate unusual noise. You can purchase spare parts of fans from INVT.



◇ Read Chapter 1 "Safety precautions" carefully and follow the instructions to perform operations. Otherwise, physical injuries or damage to the devices may be caused.

1. Stop the VFD, disconnect the AC power supply, and wait for a time no shorter than the waiting time specified on the VFD.
2. Use a screwdriver to lever up the fan mounting plate from the machine, raise up the fan mounting plate, and open the cable clamp to loose the fan cable.
3. Remove the fan cable, and remove the fan mounting plate.
4. Install the mounting plate of the fan in the VFD in the reverse steps. Ensure that the air direction of the fan is consistent with that of the VFD, as shown in the following figure.

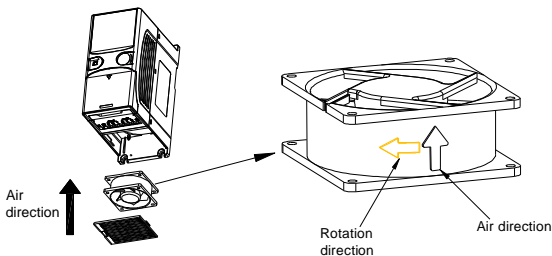

Figure 7-1 Fan maintenance for 4kW and lower VFD models

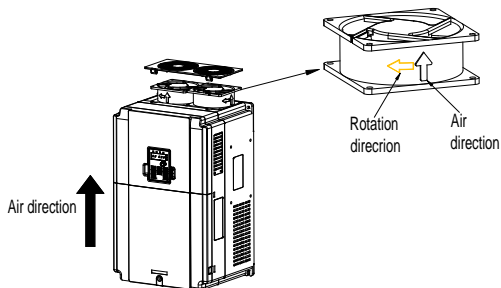

Figure 7-2 Fan maintenance for 5.5kW and higher VFD models

5. Connect the power supply.

7.1.3 Capacitor

1. Capacitor adjustment

If the VFD has been left unused for a long time, you need to follow the instructions to adjust the DC bus capacitor before using the VFD. The storage time is calculated from the delivery date.

Storage time	Operation principle
Less than 1 year	No charging operation is required.
1 to 2 years	The VFD needs to be powered on for 1 hour before it runs for the first time.
2 to 3 years	Use a voltage controlled power source to charge the VFD: Charge it at 25% of the rated voltage for 30 minutes, and then charge it at 50% of the rated voltage for 30 minutes, at 75% for another 30 minutes, and finally charge it at 100% of the rated voltage for 30 minutes.
More than 3 years	Use a voltage controlled power source to charge the VFD: Charge it at 25% of the rated voltage for 2 hours, and then charge it at 50% of the rated voltage for 2 hours, at 75% for another 2 hours, and finally charge it at 100% of the rated voltage for 2 hours.

The method for using a voltage controlled power source to charge the VFD is described as follows: The selection of a voltage controlled power source depends on the power supply of the VFD. For VFDs with an incoming voltage of 1PH/3PH 220V AC, you can use a 220V AC/2A voltage regulator. Both 1PH and 3PH VFDs can be charged with a 1PH voltage

controlled power source (connect L+ to R, and N to S or T). All the DC bus capacitors share one rectifier, and therefore they are all charged.

For VFDs of a high voltage class, ensure that the voltage requirement (such as 380 V) is met during charging. Capacitor charging requires little current, and therefore you can use a small-capacity power supply (2A is sufficient).

2. Electrolytic capacitor replacement



◇ Read Chapter 1 "Safety precautions" carefully and follow the instructions to perform operations. Otherwise, physical injuries or damage to the devices may be caused.

The electrolytic capacitor of a VFD must be replaced if it has been used for more than 35,000 hours. For details about the replacement, contact the local INVT office.

7.1.4 Power cable



◇ Read Chapter 1 "Safety precautions" carefully and follow the instructions to perform operations. Otherwise, physical injuries or damage to the devices may be caused.

1. Stop the VFD, disconnect the power supply, and wait for a time no shorter than the waiting time specified on the VFD.
2. Check the connection of the power cables. Ensure that they are firmly connected.
3. Connect the power supplies.

7.2 Fault handling



◇ Only trained and qualified electricians are allowed to perform the operations described in this chapter. Perform the operations according to the instructions in Chapter 1 "Safety precautions".

7.2.1 Alarm and fault indication

Faults are indicated by indicators. For details, see Chapter 5 "Keypad operation". When the **TRIP** indicator is on, the alarm or fault code displayed on the keypad indicates that an exception occurs on the VFD. The function codes P07.27 to P07.32 record the types of the last six faults. The function codes P07.33 to P07.40, P07.41 to P07.48, and P07.49 to P07.56 record the running data of the VFD at the last three faults, respectively. You can find out causes and solutions for most of the alarms or faults based on the information provided in this chapter. If you cannot find out the causes of an alarm or fault, contact the local INVT office.

7.2.2 Fault reset

The VFD can be reset in various ways, including pressing the **STOP/RST** key on the keypad, digital input, and disconnecting the power supply. After a fault is rectified, you can restart the motor.

7.2.3 Faults and solutions

Perform the following steps after a fault occurs:

1. After a fault occurs on the VFD, check whether an exception occurs on the keypad. If yes, contact the local INVT office.
2. If no keypad exception occurs, view the corresponding fault recording parameters in the P07 group to understand the actual states at the current fault.
3. Refer to the following table to check for exceptions.
4. Rectify the fault or ask for help.
5. After the fault is rectified, perform fault reset to run the VFD.

Fault code	Fault type	Possible cause	Corrective measure
OUt1	Inverter unit U phase protection	Acceleration is too fast; IGBT module is damaged;	Increase acceleration time; Replace the power unit; Check the drive wires; Check whether there is strong interference surrounds the peripheral device.
OUt2	Inverter unit V phase protection	Misacts caused by interference;	
OUt3	Inverter unit W phase protection	Drive wires are poorly connected; To-ground short-circuit occurs.	
OV1	Overvoltage during acceleration	Exception occurred to input voltage; Large energy feedback; Lack of braking units; Dynamic brake is not enabled.	Check the input power supply; Check whether load deceleration time is too short; or the motor starts during rotating; Install dynamic braking units; Check the setup of related function codes.
OV2	Overvoltage during deceleration		
OV3	Overvoltage during constant speed		
OC1	Overcurrent during acceleration	Acceleration or deceleration is too fast;	Increase the acceleration or deceleration time; Check the input power supply; Select the VFD with larger power; Check whether the load is short circuited (to-ground short circuit or line-to-line short circuit) or the rotation is not smooth; Check the output wiring; Check whether there is strong interference;
OC2	Overcurrent during deceleration	The voltage of the grid is low;	
OC3	Overcurrent during constant speed	The power of the VFD is low; Load transient or exception occurred; To-ground short circuit or output phase loss occur; Strong external	

Fault code	Fault type	Possible cause	Corrective measure
		interference sources; Overvoltage stall protection is not enabled.	Check the setup of related function codes.
UV	Bus undervoltage	The voltage of the grid is low; Overvoltage stall protection is not enabled.	Check the input power supply of the grid; Check the setup of related function codes.
OL1	Motor overload	The voltage of the grid is too low; The rated current is set improperly; Motor stall or load jumps violently.	Check the voltage of the grid; Set the rated current of the motor again; Check the load and adjust the torque boost.
OL2	VFD overload	The acceleration is too fast; The rotating motor is restarted; The voltage of the grid is too low; The load is too heavy; The motor power is too large, and the power of the VFD is too small.	Increase the acceleration time; Avoid restarting the motor immediately after it stops; Check the voltage of the grid; Use a VFD with greater power; Use a motor that meets the operation requirements.
SPI	Phase loss on the input side	Phase loss or violent fluctuation occurred to R, S and T input.	Check the input power supply; Check the installation wiring.
SPO	Phase loss on the output side	Phase loss occurred to U, V, W output (or the three phases of the load are seriously asymmetrical).	Check the output wiring; Check the motor and cables.
OH1	Rectifier module overheat	Air duct is blocked or fan is damaged;	Ventilate the air duct or replace the fan;
OH2	Inverter module overheat	Ambient temperature is too high; Long-time overload	

Fault code	Fault type	Possible cause	Corrective measure
		running.	
EF	External fault	SI external fault input terminal acts.	Check the external device input.
CE	485 communication fault	Baud rate is set improperly; The communication line faulty; Communication address error; Communication suffers from strong interference.	Set proper baud rate; Check the wiring of communication interfaces; Set proper communication address; Replace or change the wiring to enhance anti-interference capability.
ItE	Current detection fault	The connector of control board is in poor contact; Exception occurred to amplification circuit.	Check the connector and re-plug; Replace the main control board.
tE	Motor autotuning fault	Motor capacity does not match with the VFD capacity; Motor parameters are set improperly; The parameters gained from autotuning deviate sharply from the standard parameters; Autotuning timeout.	Change the VFD model; Set proper motor type and nameplate parameters; Empty the motor load and carry out autotuning again; Check motor wiring and parameter setup; Check whether upper limit frequency is larger than 2/3 of the rated frequency.
EEP	EEPROM operation fault	R/W error occurred to the control parameters; EEPROM is damaged.	Press the STOP/RST key to reset. Replace the main control board.
bCE	Brake unit fault	Brake circuit fault or brake tube is damaged; The resistance of external braking resistor is too small.	Check the brake unit, and replace with the new brake tubes. Increase the brake resistance.
END	Running time reached	The actual running time of the VFD is larger than the preset running time.	Ask help from the supplier, and adjust the preset running time.
OL3	Electronic overload	The VFD performs	Check the load and overload

Fault code	Fault type	Possible cause	Corrective measure
	fault	overload pre-alarm based on the set value.	pre-alarm threshold.
PCE	Keypad communication error	The keypad wire is poorly contacted or disconnected; The keypad wire is too long and suffers strong interference; Circuit fault occurred to the keypad or communication part of the main board.	Check the keypad wires to confirm whether fault exists; Check the surroundings to rule out interference source; Replace the hardware and ask for maintenance service.
UPE	Parameter upload error	The keypad wire is poorly contacted or disconnected; The keypad wire is too long and suffers strong interference; Circuit fault occurred to the keypad or communication part of the main board.	Check the surroundings to rule out interference source; Replace the hardware and ask for maintenance service;
DNE	Parameter download error	The keypad wire is poorly contacted or disconnected; The keypad wire is too long and suffers strong interference; Data storage error occurred to the keypad.	Check the surroundings to rule out interference source; Replace the hardware and ask for maintenance service; Re-backup keypad data.
ETH1	To-ground short circuit fault 1	VFD output is short connected to the ground; Current detection circuit is faulty; Actual motor power setup deviates sharply from the VFD power.	Check whether motor wiring is proper;
ETH2	To-ground short circuit fault 2		Replace the hall component; Replace the main control board; Reset the motor parameters properly; Check whether motor power parameters in P2 group are consistent with motor power

Fault code	Fault type	Possible cause	Corrective measure
			actually used.
LL	Electronic underload fault	The VFD performs underload pre-alarm based on the set value.	Check the load and underload pre-alarm threshold.
LC	Current limiting fault	The VFD performs current limit pre-alarm based on the set current limit value.	Check the set auto current limiting threshold and present current value.
FAE	Brake feedback fault	The brake feedback circuit is disconnected or poorly contacted; The brake feedback detection time is too short.	Check the brake feedback circuit; Increase the detection time P19.24 to a proper value.
tPF	Torque verification fault	The torque verification current, moment force setting, and torque verification fault detection time are set improperly.	Check the set value of torque verification current and present current value
StC	Operating lever fault	After the zeroing function is enabled, the operating lever restarts the VFD operation when it does not return to the zero position successfully (zero position detection succeeds).	Reset the start command, or properly adjust the zero-point position detection delay set in P19.38 when the zero position is detected successfully.
LSP	Low-speed running protection fault	The running frequency is too low. Frequency for low-speed running protection is set to too high.	Check the actual running frequency; Lower the frequency for low-speed running protection (P19.43) properly.
tCE	Terminal command exception	Forward and reverse running commands are given simultaneously.	Check the wiring of the forward running command; Check the wiring of the reverse running command;

Fault code	Fault type	Possible cause	Corrective measure
			View the state of input terminals, and check whether forward and reverse running command signals are sent simultaneously.
POE	Terminal command exception at power-on	The wiring of running command terminals has been short-circuited before power-on, or the polarity of terminals is set to be wrong; The state of the input terminal is inconsistent with the actual input.	Check the wiring of input terminals; Check the polarity of input terminals; View the state of the input terminals, and check whether input terminals suffer interference.
SFE	Set frequency fault	After the brake control is enabled, set P27.18 to 1 to enable the reference frequency detection. Set frequency is less than the value set in P27.19.	Check whether the frequency reference is exceptional; If the frequency is given by terminals., check whether the input terminal wiring is exceptional or interfered.
PTCE	PTC motor overtemperature fault	The terminal selects PTC signal, and the terminal is valid due to too high motor temperature.	Check whether the motor temperature is too high; Check the input terminal wiring is exceptional or interfered.
dIS	Failure to enable the VFD	The input terminal selects VFD enabling, but the terminal signal is invalid.	Check the input terminal setting and terminal signal.

7.2.4 VFD alarms and corrective measures

Alarm code	Alarm type	Possible cause	Corrective measure
A-OL	Overload protection alarm	The load is too heavy.	A-OL
A-LvP	Low voltage alarm	The bus voltage is too low.	Check whether the low voltage protection threshold is too high. Check whether the grid voltage or rectifier module is abnormal.
A-LU	Upward position	The input terminal has	Check whether the allowed

Alarm code	Alarm type	Possible cause	Corrective measure
	limit alarm	set the upward limited position reaching function, and there is a signal reference to the terminal.	highest position point has been reached. Check the input terminal signal.
A-Ld	Downward position limit alarm	The input terminal has set the downward limited position reaching function, and there is a signal reference to the terminal.	Check whether the allowed lowest position point has been reached. Check the input terminal signal.
A-Pt	PT100 disconnection alarm	PT100 wiring circuit is disconnected.	Check PT100 wiring circuit.
A-Ot	P100 overtemperature alarm	The current ambient temperature is too high. PT100 overtemperature prealarm setting is improper.	Check the current ambient temperature; Check whether PT100 overtemperature protection threshold is too low.
A-PTC	PTC overtemperature alarm	The current ambient temperature is too high.	Check the current ambient temperature; Check the input terminal signal.
A-SSF	Set frequency before brake release too small	Set frequency before brake release is less than brake release frequency.	Check whether set frequency is less than brake release frequency.
A-rSF	Set frequency after brake release too small	Set frequency after brake release is less than brake closing frequency	Check whether set frequency is less than brake closing frequency.
A-SPI	Input phase loss alarm	During stop, a loss of either input phase R, S, or T occurs or fluctuation is great.	Check the input power source and wiring.

7.2.5 Other status

Display code	Fault type	Possible cause	Corrective measure
PoFF	System power failure	The system is powered off or the bus voltage is too low.	Check the grid conditions.

8 485 communication protocol

This section describes the address definition of communication data. The addresses are used for controlling the running, obtaining the state information, and setting related function parameters of the VFD.

1. Function code address representation rules.
2. The relative address of a function code indicates the register address corresponding to the parameter, which needs to be converted into a hexadecimal value. Take P05.05 as an example, the function code address is 0505H in the hexadecimal form.
3. The MSB ranges from 00 to FF, and the LSB also ranges from 00 to FF.

Note: The parameters in the P29 group are set by the manufacturer, so you need to enter the correct factory password before reading and writing the parameters. Some parameters cannot be modified when the VFD is running; some cannot be modified regardless of the state of the VFD. Pay attention to the setting range, unit, and related description of a parameter when modifying it.

Table 8-1 485 communication address

Function	Address	Data description	R/W characteristic
Communication-based control command	2000H	0001H: Forward running	R/W
		0002H: Reverse running	
		0003H: Forward jogging	
		0004H: Reverse jogging	
		0005H: Stop	
		0006H: Coast to stop (emergency stop)	
		0007H: Fault reset	
		0008H: Jogging to stop	
Communication-based value setting	2001H	Communication-based frequency setting (0–Fmax, unit: 0.01 Hz)	R/W
	2002H	PID setting, range (0–1000, 1000 corresponds to 100.0%)	R/W
	2003H	PID feedback, range (0–1000, 1000 corresponds to 100.0%)	R/W
	2004H	Torque setting (-3000+3000, 1000 corresponds to 100.0% of the rated current of the motor)	R/W
	2005H	Setting of the upper limit of the forward	R/W

Function	Address	Data description	R/W characteristic
		running frequency (0–Fmax, unit: 0.01 Hz)	
	2006H	Setting of the upper limit of the reverse running frequency (0–Fmax, unit: 0.01 Hz)	R/W
	2007H	Upper limit of the electromotive torque (0–3000, in which 1000 corresponds to 100.0% of the rated current of the motor)	R/W
	2008H	Upper limit of the brake torque (0–3000, in which 1000 corresponds to 100.0% of the rated current of the motor)	R/W
	2009H	Special control command word: Bit 0–1: =00: Motor 1 =01: Motor 2 =10: Motor 3 =11: Motor 4 Bit 2: =1 Torque control is not disabled =0: Torque control disabled Bit 3: =1 Power consumption reset to 0 =0: Power consumption not reset Bit 4: =1 Pre-excitation =0: Pre-excitation disabled Bit 5: =1 DC brake =0: DC brake disabled	R/W
	200AH	Virtual input terminal command, range: 0x000–0x1FF	R/W
	200BH	Virtual output terminal command, range: 0x00–0x0F	R/W
	200CH	Voltage setting (for V/F separation) (0–1000, in which 1000 corresponds to 100.0% of the rated voltage of the motor)	R/W
	200DH	AO output setting 1 (-1000–+1000, in which 1000 corresponds to 100.0%)	R/W
	200EH	AO output setting 2 (-1000–+1000, in which 1000 corresponds to 100.0%)	R/W
VFD state word 1	2100H	0001H: Forward running 0002H: Reverse running 0003H: Stopped 0004H: Faulty	R

Function	Address	Data description	R/W characteristic
		0005H: POFF	
		0006H: Pre-excited	
VFD state word 2	2101H	Bit 0: =0: Not ready to run =1: Ready to run Bit 1–2: =00: Motor 1 =01: Motor 2 =10: Reserved =11: Reserved Bit 3: =0: Asynchronous machine =1: Synchronous machine Bit 4: =0: No overload prealarm =1: Overload prealarm Bit 5–Bit 6: =00: Keypad-based control =01: Terminal-based control =10: Communication-based control	R
VFD fault code	2102H	See the description of fault types.	R
VFD identification code	2103H	GD20-09-----0x0120	R
Factory bar code 1	6000H	Range: 0000–FFFF	W
Factory bar code 2	6001H	Range: 0000–FFFF	W
Factory bar code 3	6002H	Range: 0000–FFFF	W
Factory bar code 4	6003H	Range: 0000–FFFF	W
Factory bar code 5	6004H	Range: 0000–FFFF	W
Factory bar code 6	6005H	Range: 0000–FFFF	W

Table 8-2 Encoding rules of device codes

8 MSBs	Meaning	8 LSBs	Meaning
01	GD20-09	0x06	GD20-09 series VFDs
		0x07	Reserved
		0x08	Reserved
		0x09	Reserved
		0x0a	Reserved
		0x0b	Reserved
		0x0c	Reserved
		0x0d	Reserved
		0x0e	Reserved
		0x0f	Reserved
		0x10	Reserved

8 MSBs	Meaning	8 LSBs	Meaning
		0x11	Reserved
		0x13	Reserved
		0x15	Reserved

Note: A device code consists of 16 bits, 8 MSBs and 8 LSBs. The MSBs indicate a model series, and the 8 LSBs indicate a derivative model.

Table 8-3 Definitions of error message response codes

Code	Name	Definition
01H	Invalid command	<p>The command code received by the upper computer is not allowed to be executed.</p> <p>The possible causes are as follows:</p> <ul style="list-style-type: none"> The function code is applicable only on new devices and is not implemented on this device. The slave is in the faulty state when processing this request.
02H	Invalid data address	For the VFD, the data address in the request of the upper computer is not allowed. In particular, the combination of the register address and the number of the to-be-transmitted bytes is invalid.
03H	Invalid data bit	<p>The received data domain contains a value that is not allowed. The value indicates the error of the remaining structure in the combined request.</p> <p>Note: It does not mean that the data item submitted for storage in the register includes a value unexpected by the program.</p>
04H	Operation failure	The parameter is set to an invalid value in the write operation. For example, a function input terminal cannot be set repeatedly.
05H	Password error	The password entered in the password verification address is different from that set in P07.00.
06H	Data frame error	The length of the data frame transmitted by the upper computer is incorrect, or in the RTU format, the value of the CRC check bit is inconsistent with the CRC value calculated by the lower computer.
07H	Parameter read-only	The parameter to be modified in the write operation of the upper computer is a read-only parameter.

Code	Name	Definition
08H	Parameter cannot be modified in running	The parameter to be modified in the write operation of the upper computer cannot be modified during the running of the VFD.
09H	Password protection	A user password is set, and the upper computer does not provide the password to unlock the system when performing a read or write operation. The error of "system locked" is reported.

When returning a response, the slave device uses a function code domain and fault address to indicate whether it is a normal response (no error) or exception response (some errors occur). In a normal response, the slave device returns the corresponding function code and data address or sub-function code. In an exception response, the slave device returns a code that is equal to a normal code, but the first bit is logic 1.

For example, if the master device transmits a request message to a slave device for reading a group of function code address data, the code is generated as follows:

0 0 0 0 0 1 1 (03H in the hexadecimal form)

For a normal response, the same code is returned.

For an exception response, the following code is returned:

1 0 0 0 0 1 1 (83H in the hexadecimal form)

In addition to the modification of the code, the slave device returns a byte of exception code that describes the cause of the exception. After receiving the exception response, the typical processing of the master device is to transmit the request message again or modify the command based on the fault information.

Appendix A Technical data

A.1 Derated application

A.1.1 Capacity

Choose a VFD based on the rated current and power of the motor. To endure the rated power of the motor in the function parameter list, the rated output current of the VFD must be larger than or equal to the rated current of the motor. The rated power of the VFD must be higher than or equal to that of the motor.

Note:

1. The maximum allowable shaft power of the motor is limited to 1.5 times the rated power of the motor. If the limit is exceeded, the VFD automatically restricts the torque and current of the motor. This function effectively protects the input shaft against overload.
2. The rated capacity is the capacity at the ambient temperature of 40°C.
3. You need to check and ensure that the power flowing through the common DC connection in the common DC system does not exceed the rated power of the motor.

A.1.2 Derating

If the ambient temperature on the site where the VFD is installed exceeds 40°C, the altitude exceeds 1000m, or the switching frequency is changed from 4 kHz to 8, 12, or 15 kHz, the VFD needs to be derated.

A.1.2.1 Derating due to temperature

When the temperature ranges from +40°C to +50°C, the rated output current is derated by 1% for each increased 1°C. For the actual derating, see the following figure.

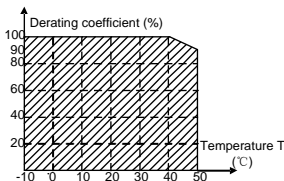

Note: It is not recommended to use the VFD at a temperature higher than 50°C. If you do, you shall be held accountable for the consequences caused.

A.1.2.2 Derating due to altitude

When the altitude of the site where the VFD is installed is lower than 1000m, the VFD can run at the rated power. When the altitude exceeds 1000m, derate by 1% for every increase of

100m. When the altitude exceeds 3000m, consult the local INVT dealer or office for details.

A.1.2.3 Derating due to carrier frequency

The power of Goodrive20-09 series VFDs for hoisting varies according to carrier frequencies. The rated power of a VFD is defined based on the carrier frequency set in factory. If the carrier frequency exceeds the factory setting, the power of the VFD is derated by 10% for each increased 1 kHz.

A.2 EMC regulations

EMC compliance declaration

European union (EU) stipulates that the electric and electrical devices sold in Europe cannot generate electromagnetic disturbance that exceeds the limits stipulated in related standards, and can work properly in environments with certain electromagnetic interference. The EMC product standard (EN 61800-3) describes the EMC standards and specific test methods for adjustable speed electrical power drive systems. Products must strictly follow these EMC regulations.

The EMC product standard (EN 61800-3) describes the EMC requirements on VFDs.

Application environment categories:

Category I: Civilian environments, including application scenarios where VFDs are directly connected to the civil power supply low-voltage grids without intermediate transformers

Category II: All environments except those in Category I.

VFD categories:

C1: Rated voltage lower than 1000 V, applied to environments of Category I.

C2: Rated voltage lower than 1000 V, non-plug, socket, or mobile devices; power drive systems that must be installed and operated by specialized personnel when applied to environments of Category I.

Note: The EMC standard IEC/EN 61800-3 no longer restricts the power distribution of VFDs, but it specifies their use, installation, and commissioning. Specialized personnel or organizations must have the necessary skills (including the EMC-related knowledge) for installing and/or performing commissioning on the electrical drive systems.

C3: Rated voltage lower than 1000 V, applied to environments of Category II. They cannot be applied to environments of Category I.

C4: Rated voltage higher than 1000 V, or rated current higher or equal to 400 A, applied to complex systems in environments of Category II.

A.2.1 VFDs of category C2

The induction disturbance limit meets the following stipulations:

1. Select an optional EMC filter according to Appendix C "Optional peripheral accessories", and install it following the description in the EMC filter manual.
2. Select the motor and control cables according to the description in the manual.
3. Install the VFD according to the description in the manual.



⚡ Currently in environments in China, the VFD may generate radio interference, you need to take measures to reduce the interference.

A.2.2 VFDs of category C3

The anti-interference performance of the VFD meets the requirements of environments Category II in the IEC/EN 61800-3 standard.

The induction disturbance limit meets the following stipulations:

1. Select an optional EMC filter according to Appendix C "Optional peripheral accessories", and install it following the description in the EMC filter manual.
2. Select the motor and control cables according to the description in the manual.
3. Install the VFD according to the description in the manual.



⚠ VFDs of C3 category cannot be applied to civilian low-voltage common grids. When applied to such grids, the VFD may generate radio frequency electromagnetic interference.

Appendix B Dimension drawings

This chapter describes the dimension drawings of Goodrive20-09 series VFDs for hoisting. The dimension unit used in the drawings is mm.

B.1 External keypad structure

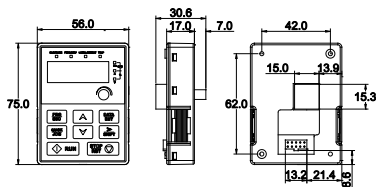

Keypad outline diagram

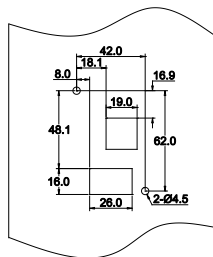

Hole-cutting diagram for non-bracket keypad

The keypad can be installed on the keypad adapter bracket if it is external. The keypad adapter bracket is optional.

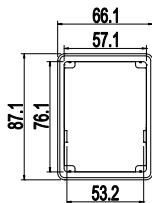

Keypad adapter bracket

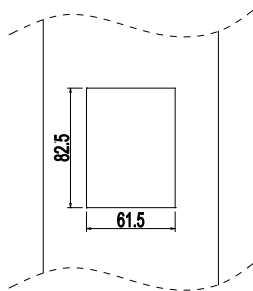

Installation dimensions

B.2 VFD dimensions

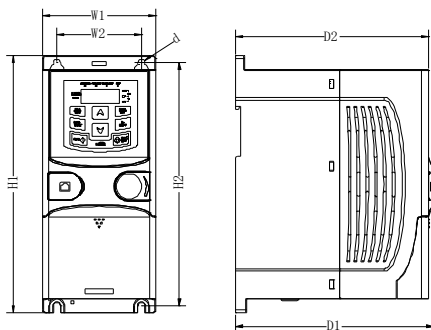

Figure B-1 Wall mounting diagram of 0.75–4kW VFDs

VFD model	Outline dimensions (mm)				Mounting dimensions (mm)		Hole diameter d (mm)
	W1	H1	D1	D2	W2	H2	
GD20-09-0R7G-4-B	80.0	185.0	140.5	137.3	60.0	175.0	5
GD20-09-1R5G-4-B	80.0	185.0	140.5	137.3	60.0	175.0	5
GD20-09-2R2G-4-B	80.0	185.0	140.5	137.3	60.0	175.0	5
GD20-09-004G-4-B	80.0	185.0	140.5	137.3	60.0	175.0	5

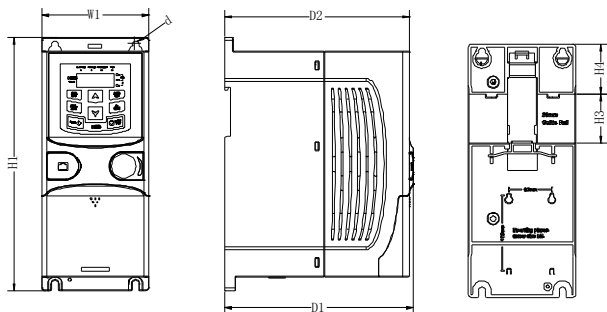

Figure B-2 Rail mounting diagram of 0.75-4kW VFDs

VFD model	Outline dimensions (mm)				Mounting dimensions (mm)		Hole diameter d (mm)
	W1	H1	D1	D2	H3	H4	
GD20-09-0R7G-4-B	80.0	185.0	140.5	137.3	35.4	36.6	5
GD20-09-1R5G-4-B	80.0	185.0	140.5	137.3	35.4	36.6	5
GD20-09-2R2G-4-B	80.0	185.0	140.5	137.3	35.4	36.6	5
GD20-09-004G-4-B	80.0	185.0	140.5	137.3	35.4	36.6	5

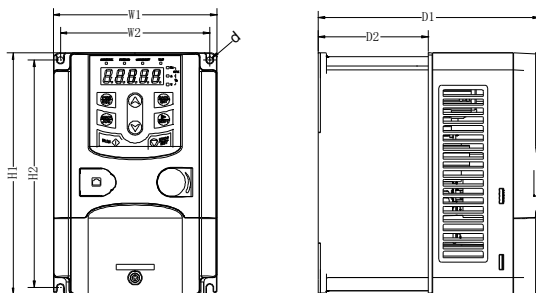

Figure B-3 Wall mounting diagram of 5.5kW VFDs

VFD model	Outline dimensions (mm)			Mounting dimensions (mm)			Hole diameter d (mm)
	W1	H1	D1	W2	H2	D2	
GD20-09-5R5G-4-B	126	186	170	115	175	84.8	5

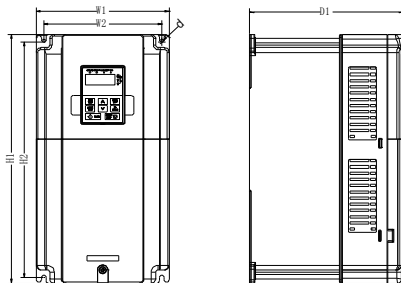

Figure B-4 Wall mounting diagram of 7.5–37kW VFDs

VFD model	Outline dimensions (mm)			Mounting dimensions (mm)		Hole diameter d (mm)
	W1	H1	D1	W2	H2	
GD20-09-7R5G-4-B	146.0	256.0	167.0	131.0	243.5	6
GD20-09-011G-4-B	170.0	320.0	196.3	151.0	303.5	6
GD20-09-015G-4-B	170.0	320.0	196.3	151.0	303.5	6
GD20-09-018G-4-B	200.0	340.6	184.6	185.0	328.6	6
GD20-09-022G-4-B	200.0	340.6	184.6	185.0	328.6	6
GD20-09-030G-4-B	250.0	400.0	202.0	230.0	380.0	6
GD20-09-037G-4-B	250.0	400.0	202.0	230.0	380.0	6

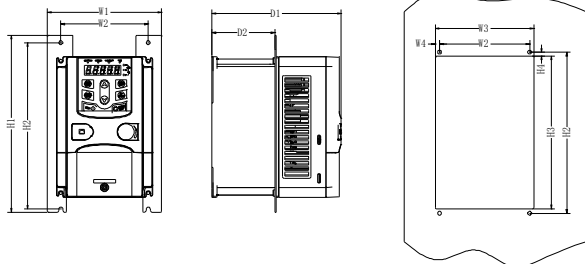

Figure B-5 Flange mounting diagram of 5.5kW VFDs

VFD model	Outline dimensions (mm)			Mounting dimensions (mm)			Hole location (mm)				Hole diameter (mm)
	W1	H1	D1	W2	H2	D2	W3	H3	W4	H4	
GD20-09-5R5G-4-B	150.2	234	201	115	220	83	130	190	7.5	13.5	5

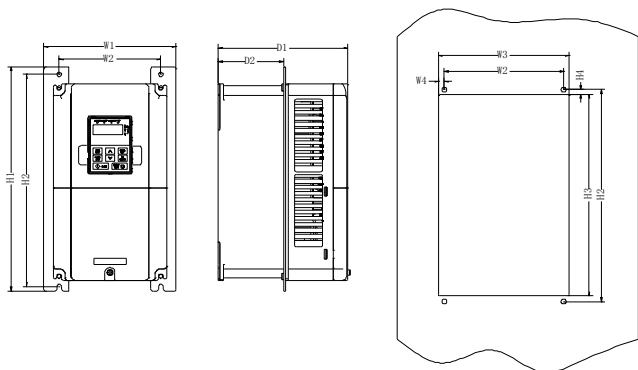

Figure B-6 Flange mounting diagram of 7.5–37kW VFDs

VFD model	Outline dimensions (mm)			Mounting dimensions (mm)			Hole location (mm)				Hole diameter (mm)
	W1	H1	D1	W2	H2	D2	W3	H3	W4	H4	
GD20-09-7R5G-4-B	170.2	292	167	131	276	84	150	260	9.5	6	6
GD20-09-011G-4-B	191.2	370	196.3	151	351	113	174	324	11.5	12	6
GD20-09-015G-4-B	191.2	370	196.3	151	351	113	174	324	11.5	12	6
GD20-09-018G-4-B	266	371	184.6	250	250	104	224	350.6	13	50.3	6
GD20-09-022G-4-B	266	371	184.6	250	250	104	224	350.6	13	50.3	6
GD20-09-030G-4-B	316	430	202	300	300	118.3	274	410	13	55	6
GD20-09-037G-4-B	316	430	202	300	300	118.3	274	410	13	55	6

Note: The flange mounting plate is optional during the flange mounting.

Appendix C Optional peripheral accessories

This chapter describes how to select optional accessories of Goodrive20-09 series VFDs.

C.1 Wiring of peripheral accessories

The following figure shows the external wiring of a Goodrive20-09 series VFD.

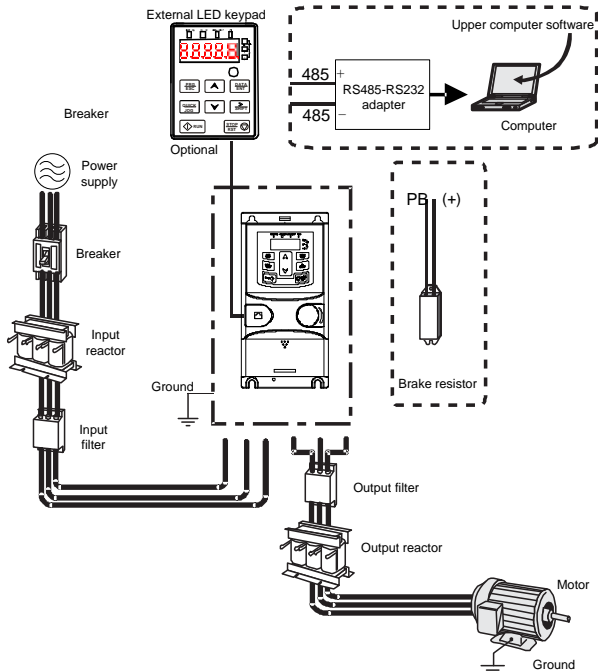



Image	Name	Description
	External keypad	This device includes the external keypads with and without the function of parameter copying. When the external keypad with the function of parameter









Image	Name	Description
		copying is enabled, the local keypad is off; when the external keypad without the function of parameter copying is enabled, the local and external keypads are on at the same time.
	Cable	Accessory for signal transmission.
	Breaker	Device for electric shock prevention and protection against short-to-ground that may cause current leakage and fire. Select residual-current circuit breakers (RCCBs) that are applicable to VFDs and can restrict high-order harmonics, and of which the rated sensitive current for one VFD is larger than 30mA.
	Input reactor	Accessories used to improve the power factor on the input side of the VFD, and thus restrict high-order harmonic currents.
	Input filter	Accessory that restricts the electromagnetic interference generated by the VFD and transmitted to the public grid through the power cable. Try to install the input filter near the input terminal side of the VFD.
	Braking resistor	Accessories used to consume the regenerative energy of the motor to reduce the deceleration time. Goodrive20-09 series VFDs need only to be configured with braking resistors.
	Output filter	Accessory used to restrict interference generated in the wiring area on the output side of the VFD. Try to install the output filter near the output terminal side of the VFD.
	Output reactor	Accessory used to lengthen the valid transmission distance of the VFD, which effectively restrict the transient high voltage generated during the switch-on and switch-off of the IGBT module of the VFD.

Image	Name	Description
	Membrane of heat releasing holes at the side	Accessory applies to severe environment for improving protective effect. The machine is derated by 10% if this membrane is used.

C.2 Power supply

	◇ Ensure that the voltage class of the VFD is consistent with that of the grid.
--	---

C.3 Cables

C.3.1 Power cables

The sizes of the input power cables and motor cables must meet the local regulation.

Note: If the conductivity of the shield layer of the motor cables cannot meet the requirements, separate PE conductors must be used.

C.3.2 Control cables

All analog control cables and cables used for frequency input must be shielded cables.

Relay cables need to be those with metal braided shield layers.

Keypads need to be connected by using network cables. In complicated electromagnetic environments, shielded network cables are recommended.

Note:

- Analog signals and digital signals cannot use the same cables, and their cables must be arranged separately.
- Check the insulation conditions of the input power cable of a VFD before connecting it.

VFD model	Recommended cable size (mm ²)		Size of connectable cable (mm ²)			Terminal screw specification	Tightening torque (Nm)
	RST	PE	RST	PB, (+)	PE		
	UVW		UVW				
GD20-09-0R7G-4-B	1.5	1.5	1-1.5	1-1.5	1-1.5	M3	0.8
GD20-09-1R5G-4-B	1.5	1.5	1-1.5	1-1.5	1-1.5	M3	0.8
GD20-09-2R2G-4-B	1.5	1.5	1-1.5	1-1.5	1-1.5	M3	0.8
GD20-09-004G-4-B	1.5	1.5	1-1.5	1-1.5	1-1.5	M3	0.8
GD20-09-5R5G-4-B	2.5	2.5	2.5-6	2.5-6	2.5-6	M4	1.13
GD20-09-7R5G-4-B	2.5	2.5	2.5-6	2.5-6	2.5-6	M4	1.13
GD20-09-011G-4-B	6	6	4-10	4-10	4-10	M5	2.3

VFD model	Recommended cable size (mm ²)		Size of connectable cable (mm ²)			Terminal screw specification	Tightening torque (Nm)
	RST	PE	RST	PB, (+)	PE		
	UVW		UVW				
GD20-09-015G-4-B	6	6	4-10	4-10	4-10	M5	2.3
GD20-09-018G-4-B	10	10	10-16	10-16	10-16	M5	2.3
GD20-09-022G-4-B	16	16	10-16	10-16	10-16	M5	2.3
GD20-09-030G-4-B	25	16	25-50	25-50	16-25	M6	2.5
GD20-09-037G-4-B	25	16	25-50	25-50	16-25	M6	2.5

Note:

1. Cables of the sizes recommended for the main circuit can be used in scenarios where the ambient temperature is lower than 40°C, the wiring distance is shorter than 100m, and the current is the rated current.
2. The terminals (+) and PB are used to connect to braking resistor.
3. If the control cable and power cable need to be crossed, ensure that the angle between the control cable and the power cable is 90 degrees.
4. If the inside of the motor is wet, the insulation resistance will decrease. If you think there is moisture inside the motor, dry the motor and re-measure it.

C.4 Breaker and electromagnetic contactor

You need to add a fuse to prevent overload.

You need to configure a manually manipulated molded case circuit breaker (MCCB) between the AC power supply and VFD. The breaker must be locked in the open state to facilitate installation and inspection. The capacity of the breaker needs to be 1.5 to 2 times the rated current of the VFD.



◇ According to the working principle and structure of breakers, if the manufacturer's regulation is not followed, hot ionized gases may escape from the breaker enclosure when a short-circuit occurs. To ensure safe use, exercise extra caution when installing and placing the breaker. Follow the manufacturer's instructions.

To ensure safety, you can configure an electromagnetic contactor on the input side to control the switch-on and switch-off of the main circuit power, so that the input power supply of the VFD can be effectively cut off when a system fault occurs.

VFD model	Fuse (A)	Breaker (A)	Rated current of the contactor (A)
GD20-09-0R7G-4-B	6	6	9
GD20-09-1R5G-4-B	10	10	9
GD20-09-2R2G-4-B	10	10	9
GD20-09-004G-4-B	25	25	25
GD20-09-5R5G-4-B	35	32	25
GD20-09-7R5G-4-B	50	40	38
GD20-09-011G-4-B	63	63	50
GD20-09-015G-4-B	63	63	50
GD20-09-018G-4-B	100	100	65
GD20-09-022G-4-B	100	100	80
GD20-09-030G-4-B	125	125	95
GD20-09-037G-4-B	150	160	115

C.5 Reactors

When the voltage of the grid is high, the transient large current that flows into the input power circuit may damage rectifier components. You need to configure an AC reactor on the input side, which can also improve the power factor on the input side.

When the distance between the VFD and motor is longer than 50m, the parasitic capacitance between the long cable and ground may cause large leakage current, and overcurrent protection of the VFD may be frequently triggered. To prevent this from happening and avoid damage to the motor insulator, compensation must be made by adding an output reactor. When a VFD is used to drive multiple motors, take the total length of the motor cables (that is, sum of the lengths of the motor cables) into account. When the total length is longer than 50m, an output reactor must be added on the output side of the VFD. If the distance between the VFD and motor is 50m to 100m, select the reactor according to the following table. If the distance is longer than 100m, contact INVT's technical support technicians.

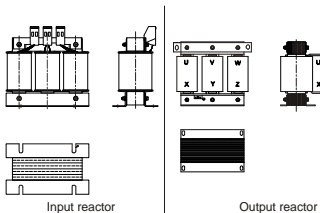

VFD model	Input reactor	Output reactor
GD20-09-0R7G-4-B	ACL2-1R5-4	OCL2-1R5-4
GD20-09-1R5G-4-B	ACL2-1R5-4	OCL2-1R5-4
GD20-09-2R2G-4-B	ACL2-2R2-4	OCL2-2R2-4
GD20-09-004G-4-B	ACL2-004-4	OCL2-004-4
GD20-09-5R5G-4-B	ACL2-5R5-4	OCL2-5R5-4
GD20-09-7R5G-4-B	ACL2-7R5-4	OCL2-7R5-4
GD20-09-011G-4-B	ACL2-011-4	OCL2-011-4
GD20-09-015G-4-B	ACL2-015-4	OCL2-015-4
GD20-09-018G-4-B	ACL2-018-4	OCL2-018-4
GD20-09-022G-4-B	ACL2-022-4	OCL2-022-4
GD20-09-030G-4-B	ACL2-037-4	OCL2-037-4
GD20-09-037G-4-B	ACL2-037-4	OCL2-037-4

Note:

1. The rated input voltage drop of input reactors is 2%±15%. The rated output voltage drop of output reactors is 1%±15%.
2. The preceding table describes external accessories. You need to specify the ones you choose when purchasing accessories.

C.6 Filters**C.6.1 C3 filter model description**

FLT-P04003L-C-G
 A
 B
 C
 D
 E
 F
 G

Field identifier	Field description
A	FLT: Name of the VFD filter series
B	Filter type P: Power input filter L: Output filter
C	Voltage class 04: AC 3PH 380 V (-15%)–440 V (+10%)
D	3-digit development serial number. For example, "003" stands for the serial number of C3 filters in development.
E	Filter performance L: General H: High-performance
F	Utilization environment of the filters A: Environment Category I, C1 (EN 61800-3)

Field identifier	Field description
	B: Environment Category I, C2 (EN 61800-3) C: Environment Category II, C3 (EN 61800-3)
G	Lot No. G: Special for external C3 filter

C.6.2 C3 filters

Goodrive20-09 series 3PH 380V, 4kW and lower VFD models can satisfy the requirements of IEC 61800-3 C3 as shown in the table below. 3PH 380V, 4kW and higher VFD models can be set to satisfy the requirements of IEC 61800-3 C3 or not by jumper J10. (**Note:** Jumper J10 is put in the same bag with operation manual)

Note: Disconnect J10 when either of below situations occurs:

1. The EMC filter is applicable to the neutral-grounded grid system. If it is used for the IT grid system (that is, non-neutral grounded grid system), disconnect J10.
2. If leakage protection occurs during configuration of a residual-current circuit breaker, disconnect J10.

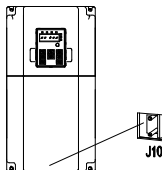

Interference filters on the input side can reduce the interference of VFDs (when used) on the surrounding devices.

Noise filters on the output side can decrease the radio noise caused by the cables between VFDs and motors and the leakage current of conducting wires.

INVT provides some of the filters for users to choose.

VFD model	Input filter
GD20-09-0R7G-4-B	FLT-P04007L-C-G
GD20-09-1R5G-4-B	
GD20-09-2R2G-4-B	
GD20-09-004G-4-B	

Note:

1. The input EMI meets the C3 requirements after an input filter is configured.
2. The preceding table describes external accessories. You need to specify the ones you choose when purchasing accessories.

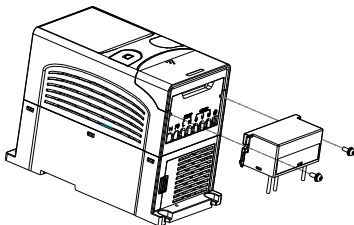
C.6.3 Installation instruction for C3 filter

The installation procedures for C3 filter are as below:

1. Connect the filter cable to the corresponding input terminal of the VFD according to the label;
2. Fix the filter onto the VFD with M3*10 screws (as shown in above picture).

C.6.4 C2 filter model description

FLT-P04016L-B
A B C D E F

Field identifier	Field description
A	FLT: Name of the VFD filter series
B	Filter type P: Power input filter L: Output filter
C	Voltage class 04: AC 3PH 380 V (-15%)–440 V (+10%)
D	3-digit code indicating the rated current. For example, "016" indicates 16 A.
E	Filter performance L: General H: High-performance
F	Filter application environment A: Environment Category I, C1 (EN 61800-3) B: Environment Category I, C2 (EN 61800-3)

C.6.5 C2 filters

VFD model	Input filter	Output filter
GD20-09-0R7G-4-B	FLT-P04006L-B	FLT-L04006L-B
GD20-09-1R5G-4-B		
GD20-09-2R2G-4-B		
GD20-09-004G-4-B	FLT-P04016L-B	FLT-L04016L-B
GD20-09-5R5G-4-B		
GD20-09-7R5G-4-B	FLT-P04032L-B	FLT-L04032L-B
GD20-09-011G-4-B		
GD20-09-015G-4-B	FLT-P04045L-B	FLT-L04045L-B
GD20-09-018G-4-B		
GD20-09-022G-4-B	FLT-P04065L-B	FLT-L04065L-B
GD20-09-030G-4-B		
GD20-09-037G-4-B	FLT-P04100L-B	FLT-L04100L-B

Note:

1. The input EMI meets the C2 requirements after an input filter is configured.
2. The preceding table describes external accessories. You need to specify the ones you choose when purchasing accessories.

C.7 Braking resistors

C.7.1 Braking resistor selection

When a VFD driving a high-inertia load decelerates or needs to decelerate abruptly, the motor runs in the power generation state and transmits the load-carrying energy through the inverter bridge to the DC circuit of the VFD, causing the bus voltage of the VFD to rise. If the bus voltage exceeds a specific value, the VFD reports an overvoltage fault. To prevent this from happening, you need to configure brake components.

	<ul style="list-style-type: none"> ✧ The design, installation, commissioning, and operation of the device must be performed by trained and qualified professionals. ✧ Follow all the "Warning" instructions during the operation. Otherwise, major physical injuries or property loss may be caused. ✧ Only qualified electricians are allowed to perform the wiring. Otherwise, damage to the VFD or braking resistors may be caused. ✧ Read the braking resistor instruction carefully before connecting them to the VFD. ✧ Connect braking resistors only to the terminals PB and (+). Do not connect them to other terminals. Otherwise, damage to the brake circuit and VFD, and fire may be caused.
--	--





✧ Connect the brake components to the VFD according to the wiring diagram. If the wiring is not properly performed, damage to the VFD or other devices may be caused.

VFD model	Braking resistor						
	Rated continuous braking current (A)	Max. peak braking current (A)	Recommended resistance (Ω)	Resistance applicable to 100% braking torque (Ω)	Recommended min. power in lifting (kW)	Recommended min. power in horizontal moving (kW)	Min. allowable resistance (Ω)
GD20-09-0R7G-4-B	2	2.4	440	653	≥0.38	≥0.2	240
GD20-09-1R5G-4-B	4	4.8	220	326	≥0.75	≥0.4	170
GD20-09-2R2G-4-B	5.4	6.5	200	222	≥1.1	≥0.5	130
GD20-09-004G-4-B	8.8	10.5	110	122	≥2	≥1	80
GD20-09-5R5G-4-B	11.6	14	80	89	≥2.8	≥1.4	60
GD20-09-7R5G-4-B	14.9	17.8	60	65	≥3.8	≥1.9	47
GD20-09-011G-4-B	22.6	27	41	44	≥5.5	≥2.8	31
GD20-09-015G-4-B	30.4	36.5	30	32	≥7.5	≥3.8	23
GD20-09-018G-4-B	36.8	44.2	25	27	≥9	≥4.5	19
GD20-09-022G-4-B	41	49.4	20	22	≥11	≥5.5	17
GD20-09-030G-4-B	54	65	15	17	≥15	≥7.5	13
GD20-09-037G-4-B	63.6	76.4	13	13	≥18.5	≥9	11

Note:

1. Select braking resistors according to the resistance and power data provided by our company.
2. The braking resistor may increase the brake torque of the VFD. The preceding table describes the resistance and power for 100% brake torque, 10% brake usage, 50% brake usage, and 80% brake usage. You can select the brake system based on the actual operation conditions.

	⚡ Do not use braking resistors whose resistance is lower than the specified minimum resistance. VFDs do not provide protection against overcurrent caused by resistors with low resistance.
	⚡ In scenarios where brake is frequently implemented, that is, the brake usage is greater than 10%, you need to select a braking resistor with higher power as required by the operation conditions according to the preceding table.

C.7.2 Braking resistor installation

Braking resistor cables need to be shielded cables.

All resistors need to be installed in places with good cooling conditions.

	⚡ The materials near the braking resistor must be non-flammable. The surface temperature of the resistor is high. Air flowing from the resistor is of hundreds of degrees Celsius. Prevent any materials from coming into contact with the resistor.
--	--

Goodrive20-09 series VFDs need only external braking resistors. PB and (+) are the terminals for connecting braking resistors. Installation of braking resistors is shown in the following figure.

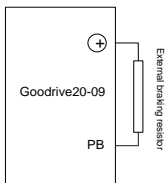
**C.8 Leakage current and RCD**

VFDs output high-frequency PWM voltage to drive motors. In this process, the distributed capacitance between the internal IGBT of a VFD and the heat sink and that between the stator

and rotor of a motor may inevitably cause the VFD to generate high-frequency leakage current to the ground. A residual current operated protective device (RCD) is used to detect the power-frequency leakage current when a grounding fault occurs on a circuit. The application of a VFD may cause misoperation of a RCD.

1. Rules for selecting RCDs

- (1) VFD systems are special. In these systems, it is required that the rated residual current of common RCDs at all levels is larger than 200mA, and the VFDs are grounded reliably.
- (2) For RCDs, the time limit of an action needs to be longer than that of a next action, and the time difference between two actions need to be longer than 20ms. For example, 1s, 0.5s, and 0.2s.
- (3) For circuits in VFD systems, electromagnetic RCDs are recommended. Electromagnetic RCDs have strong anti-interference capability, and thus can prevent the impact of high-frequency leakage current.

Electronic RCD	Electromagnetic RCD
Low cost, high sensitivity, small in volume, susceptible to voltage fluctuation of the grid and ambient temperature, weak anti-interference capability	Requiring highly sensitive, accurate, and stable zero-phase sequence current transformer, using permalloy high-permeability materials, complex process, high cost, not susceptible to voltage fluctuation of the power supply and ambient temperature, strong anti- interference capability

2. Solution to RCD misoperation (handling the VFD)

- (1) Try to remove the jumper cap at "EMC/J10" on the middle casing of the VFD.
- (2) Try to reduce the carrier frequency to 1.5 kHz (P00.14=1.5).
- (3) Try to modify the modulation mode to "3PH modulation and 2PH modulation" (P8.40=0).

3. Solution to RCD misoperation (handling the system power distribution)

- (1) Check and ensure that the power cable is not soaking in water.
- (2) Check and ensure that the cables are not damaged or spliced.
- (3) Check and ensure that no secondary grounding is performed on the neutral wire.
- (4) Check and ensure that the main power cable terminal is in good contact with the air switch or contactor (all screws are tightened).
- (5) Check 1PH powered devices, and ensure that no earth lines are used as neutral wires by these devices.
- (6) Do not use shielded cables as VFD power cables and motor cables.

VFD model	RCD (A)	Recommended brand	Recommended model
GD20-09-0R7G-4-B	6	CHNT	DZ20L series
GD20-09-1R5G-4-B	10		
GD20-09-2R2G-4-B	10		
GD20-09-004G-4-B	25		
GD20-09-5R5G-4-B	32		
GD20-09-7R5G-4-B	40		
GD20-09-011G-4-B	63		
GD20-09-015G-4-B	63		
GD20-09-018G-4-B	100		
GD20-09-022G-4-B	100		
GD20-09-030G-4-B	125		
GD20-09-037G-4-B	160		

C.9 Recommended PTC model selection

Thermistor	Recommended brand	Recommended series	Recommended model	
			Temperature	Model
PTC	TDK	M1300 series	100℃	B59300M1100A070
			110℃	B59300M1110A070
			120℃	B59300M1120A070
			130℃	B59300M1130A070
			140℃	B59300M1140A070
			150℃	B59300M1150A070
			160℃	B59300M1160A070
			180℃	B59300M1180A070

Appendix D Further information

D.1 Product and service queries

Should you have any queries about the product, contact the local INVT office. Provide the model and serial number of the product you query about. You can visit www.invt.com to find a list of INVT offices.

D.2 Feedback on INVT VFD manuals

Your comments on our manuals are welcome. Visit www.invt.com, directly contact online service personnel or choose **Contact Us** to obtain contact information.

D.3 Documents on the Internet

You can find manuals in the PDF format and other product documents on the Internet. Visit www.invt.com and choose **Service and Support > Data Download**.



Service line: 86-755-23535967 E-mail: overseas@invt.com.cn Website: www.invt.com

The products are owned by **Shenzhen INVT Electric Co.,Ltd.**

Two companies are commissioned to manufacture: (For product code, refer to the 2nd/3rd place of S/N on the name plate.)

Shenzhen INVT Electric Co.,Ltd. (origin code: 01)

Address: INVT Guangming Technology Building, Songbai Road,
Matian, Guangming District, Shenzhen, China

INVT Power Electronics (Suzhou) Co.,Ltd. (origin code: 06)

Address: No. 1 Kunlun Mountain Road, Science & Technology
Town, Gaoxin District, Suzhou, Jiangsu, China

Industrial Automation: ■ HMI

■ Elevator Intelligent Control System

■ PLC

■ VFD

■ Servo System

■ Rail Transit Traction System

Energy & Power:

■ UPS

■ DCIM

■ Solar Inverter

■ SVG

■ New Energy Vehicle Powerstain System

■ New Energy Vehicle Charging System

■ New Energy Vehicle Motor

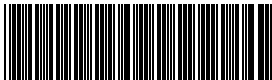

66001-00752

Copyright© INVT.

Manual information may be subject to change without prior notice.

202008 (V1.0)